

Natural Turf for Sport

Updated guidance for 2011

Foreword

Sport England believes that good facilities are fundamental to developing sporting opportunities for everyone, from the youngest beginner to the international class athlete. The provision of good quality facilities, whether large or small, can be a springboard for developing civic pride and assisting the process of regenerating deprived neighbourhoods. Facilities that are well designed, built to last and well maintained are a pleasure to use and give ample return on the time and money invested in their construction and day to day management.

Good design needs to be based on a sound understanding of the current trends and practices within individual sports, developments in the sport and leisure industry and the lessons learnt from previously built schemes.

It is essential that this is embraced from the beginning of a particular project and instilled in the initial briefing stage through to the final detailed specifications and operational arrangements.



Sport England Design Guidance Notes aim to promote a greater general understanding of overall design concepts as well as an appreciation of technical issues and the critical design factors for individual sports. These need to be considered in reaching the appropriate solution for a particular project. They also advise where further information, advice and expertise may be found and point to benchmark examples.

Sport England's Design and Development Guidance Notes aim to:

- ***Increase awareness of good design in sports facilities***
- ***Help key building professions, clients, user representatives and other stakeholders to follow best practice***
- ***Encourage the development of well designed sports facilities that meet the needs of sports and are a pleasure to use.***

Contents

1.0 Introduction	4	
• Avoiding common problems		
• Development of standards		
• An overview of sports turf technology		
◦ Soil types		
◦ Drainage		
◦ Pitch economics and other factors		
2.0 General Project Planning	8	
• Key project stages		
• Appointing a competent pitch consultant		
• User profile		
• Location of playing surfaces		
• Requirements for proposed activities		
• Feasibility study		
• Site surveys		
• Ground conditions		
• Planning and other consents		
3.0 General Pitch Construction	13	
• Contracts and contractors		
• Site clearance		
• Adjustments to the surface levels		
• Drainage - general principles		
• Cultivation and seeding		
• General maintenance		
• Maintenance equipment		
4.0 Football and Rugby Pitches	19	
• Designing for likely use		
• Pitch configuration		
• Pitch construction		
◦ Type 1: Undrained		
◦ Type 2: Pipe drained		
◦ Type 3: Pipe drained with mole drains		
◦ Type 4: Pipe drained with sand grooves		
◦ Type 5: Pipe drained with slit drains		
◦ Type 6: Pipe drained with topsoil and drainage layer		
◦ Type 7: Pipe drained with suspended water table		
◦ Summary of pitch drainage types		
• Cultivation		
• Grass cover		
• Upgrading pipe drained pitches		
• Sand amelioration		
• Irrigation		
• Maintenance		
◦ Summer Rugby League: Summary pitch maintenance programme		
◦ Winter Football and Rugby League: Summary pitch maintenance programme		
5.0 Flat and Crown Bowling Greens	33	
• Site considerations		
• Grading		
• Drainage		
• Ditch channels		
• Rootzone		
• Preparation		
• Seed bed / turf bed preparation		
• Green surrounds		
• Maintenance		
◦ A summary maintenance programme for bowling greens		
6.0 Cricket Grounds	38	
• Initial planning		
• Site investigation		
• Falls		
• Materials		
• Drainage		
• Constuction		
• Seeding		
• Irrigation		
• Outfield		
• Outfield drainage		
• Grass cover		
• Maintenance		
• Equipment		
• Non turf pitches		
◦ A summary maintenance programme for cricket squares		

Appendices (See overleaf)

Appendix 1	43
• Selection criteria for consultants on turf / grass projects	
Appendix 2	44
• Schedule of services for a sports turf consultant employed on playing field and natural turf pitch improvement schemes	
Appendix 3	47
• Key project stages	
Appendix 4	50
• Performance Quality Standards	
Appendix 5	51
• Maintenance resource check list	
Appendix 6	52
• Playing areas	
◦ Mini soccer	
◦ Youth football	
◦ Senior football	
◦ with sand grooves	
◦ with mole drains	
◦ with slit drains	
◦ Rugby Union	
◦ Rugby League	
◦ Softball	
◦ Baseball	
◦ Cricket	
◦ Standard pitch layout	
◦ Combined cricket and winter games pitches	
◦ Pitch markings	
Appendix 7	65
• Related organisations	
Appendix 8	67
• Glossary of natural turf terms	

1.0 Introduction

This guidance note highlights the key issues that need to be considered in the construction of safe and sustainable natural turf pitches. It should be used as a point of reference in the process to ensure that suitable playing surfaces are created and maintained.

It focuses principally on pitches for the following sports¹:

- Baseball / Softball
- Cricket
- Football
- Rugby Union and League.

Appropriate planning, design, management and maintenance are critical factors and except for the smallest of projects, advice must be sought from qualified, experienced and independent professionals.

Seek expert advice from experienced, qualified and independent professionals from the start of a project.

Timely consideration of the pertinent issues will result in a good quality playing surface. This should ensure it is appropriate for the planned level, type and quantity of use and be physically as well as financially sustainable in the long term.

¹ For **golf** see: STRI – Guidelines for Golf Green Construction - Dr Stephen Baker
<http://www.stri.co.uk>

The European Institute of Golf Course Architects -
<http://www.eigca.org/>

The United States Golf Association
<http://www.usga.org/>

For **hockey** see: Sport England Design Guidance Note 'Artificial Surfaces for Outdoor Sport'

For **tennis** see: LTA 'Grass Court Guidance'
<http://www.lta.org.uk/>

STRI - 'Grass Tennis Courts How to Construct and Maintain them.' J Perris
<http://www.stri.co.uk/>

Avoiding common problems

It is essential to consider in detail all the implications of the proposal before deciding how to proceed. Failure to consider all aspects of the project early in the development process may result in lost opportunities and sub-optimal facilities. It may not be possible to correct resultant problems without making radical alterations to the construction.

Lack of appropriate planning in the early stages of the design of natural turf playing surfaces could be costly and severely affect the long-term viability of the project. A poorly considered proposal resulting in a mediocre facility will discourage users and/or increase maintenance costs to unsustainable levels.

Common problems can be summarised as:

- Inadequate site assessment
- Inappropriate specification
- Ineffective monitoring during the construction phase
- Poor site management
- Inexperienced contractors
- Unsuitable materials
- Inappropriate timing of construction work
- Inadequate maintenance
- Overuse.

The construction and maintenance of safe and sustainable natural turf surfaces is a fundamental prerequisite for the safety and enjoyment of participants of sport from the community level through to the professional game.

Development of standards

There have been a number of initiatives within the industry to define minimum standards and improve the quality of pitches. In particular the development of:

- Codes of Practice for Design, Construction and Maintenance (SAPCA)
- Performance Quality Standards (PQS)
- Model Contract Specifications².

Performance Quality Standards (PQS) were originally developed by a voluntary technical consortium comprising representatives from the Sports Turf Research Institute (STRI), National Playing Fields Association (NPFA) and the Institute of Groundsmanship (IOG). They provided a mechanism for objectively benchmarking the quality and performance of natural turf sports surfaces.

Sport England successfully used the concept for the 'Playing Field and Green Spaces Programme' in 2003 and have since promoted the use of PQS's as key criteria for the design, procurement and construction of natural turf sports pitches. They provide a way to ensure that natural turf playing surfaces are constructed and maintained at an acceptable standard against a defined benchmark for a particular level of play.

A summary of PQS information is presented in Appendix 4 and represents selected key minimum criteria for football rugby and cricket³.



A well-designed surface, properly constructed and maintained, is enjoyable to play on

² Downloadable from the Sport England website.

³ See IOG publications or specific guidelines for cricket set out in '*Recommended Guidelines for the construction, preparation and maintenance of cricket pitches and outfielders at all levels of the game*'. www.ecb.co.uk

An overview of sports turf technology

It is helpful to understand some of the science behind the design and engineering of natural turf and to appreciate that there are certain limitations. This requires specialist knowledge of soils, drainage and agronomy.

A natural turf surface is dependent upon the health of the grass and the type and strength of the soil. Inappropriate conditions and excessive usage can cause a cycle of wear and damage that needs to be limited through good sustainable design and maintenance.

Grass, like most plants needs light and heat from the sun, carbon dioxide and oxygen from the atmosphere and structure, water, oxygen and nutrients from the soil. When any of these components is compromised, the grass plant will suffer and will not recover from the stress of play.

Good natural turf sports surface design aims to ensure that the plant has sufficient, but not excess, of all these components.

A natural turf surface is dependent upon the health of the grass and the type and strength of the soil.

Soil types:

The proportions of sand, silt and clay particles within soils influence the characteristics that make them more or less suitable for individual sports. For example, sports like cricket and tennis, where ball bounce is critical, are best played on dry, compacted clay soils. A cricket pitch is hard when it is dry but will soon lose strength when it becomes wet – this is why rain can stop play.

In contrast, elite-level football and rugby are mainly played on very sandy soils. The reason for this is because sandy soils drain quickly and the strength does not change as much when the soil is wetted as in a clay soil. In football and rugby, play goes on when it rains so the surfaces must be able to maintain strength. Without strength in the soil, players will not be able to generate traction and playability is affected.



Poorly constructed and / or maintained playing surfaces are dangerous, affect quality of play and limit use

Drainage:

Good drainage contributes to maintaining surface strength and helps to maintain oxygen within the soil for plant roots. Sandy soils drain best, and this explains why many well known natural turf surfaces such as the Wembley pitch, the outfield at Lord's and the greens at many golf clubs have been constructed from sand.

But these are constructed surfaces, that required the sand to be imported to build the pitch. The reality in England is that most natural turf pitches are not built in this way. They tend to be located on the native soils that may often be poorly draining clay/silt soils.

However, drainage systems needs to be sustainable. Installing a drainage system into a clay soil increases the rate at which water reaches watercourses during a storm and for this reason drainage is becoming increasingly more regulated to help reduce the impact of flooding.

Pitch economics and other factors:

It might seem that the obvious solution is to build sand construction pitches but this is expensive because significant quantities of imported sand are required. So whilst this might be a solution for relatively smaller bowling greens, it is extremely expensive for large football and rugby pitches.

Other factors also come into play. Sands are naturally very free draining (helping remove excess surface water) but this can cause drought stress to the plant, meaning that an irrigation system is required. Again this might be possible for bowling greens but on football and rugby pitches, a large-scale irrigation system will be required adding extra cost to the initial construction. In addition,

water for irrigation adds extra cost to the ongoing maintenance budget and is likely to be more expensive to source as demand for water increases and supplies are stretched.

Sand soils also lack the nutrient retention properties of clay soils. This means that nutrients are washed from the soil, away from the plant and have to be replenished more frequently, increasing the fertilizer bill.

There are alternative and more sustainable strategies not requiring large amounts of imported sand, that still focus on improving drainage. By diverting the water from the poorly draining soils at the surface, to collector drains located below the surface via 'grooves' or 'slits' cut into the surface and then filled with permeable sand. The sand provides a 'super-highway' for water to move away from the surface where ball, player contact and wear takes place. These solutions still require maintenance but generally do not require irrigation or as much fertilizer as a full sand construction.

Sports pitches and the wider public realm.

See the following documents:

- ***For guidance on producing playing pitch strategies:***

'Towards a Level Playing Field: A Guide to the Production of Playing Pitch Strategies'

Sport England / CCPR document - see Sport England website.

- ***'Green Space Strategies - a good practice guide' by CABI SPACE on how sport pitch provision can relate to strategies in the wider public realm. The guidance draws on the principles of the Government's Planning Policy Guidance Note 17 and will help contribute to national objectives for better public spaces.***

www.cabi.org.uk/publications/green-space-strategies

- ***Specific sports have their own turf performance criteria that are tailored to the level of the game played. These provide a benchmark for the effective assessment, design, construction and maintenance of natural turf pitches.***

See Appendix 4.

2.0 General Project Planning

Key project stages

As with any construction project, it is important to proceed in a logical and efficient sequence. The key stages, project information and decisions are summarised below. However, more detailed guidance is provided in Appendix 3.

- **Preparation**
 - Appraisal of requirements
 - Business justification
- **Design**
 - Outline proposals
 - Scheme and planning
 - Detailed design
- **Preconstruction**
 - Detailed design information
 - Tender documentation
 - Tender process
- **Construction**
 - Project planning
 - Construction
 - Practical completion
- **Use**
 - Completion
 - On going maintenance.

The following paragraphs in this section describe some of the key issues that need to be considered when developing new or improved pitches. A competent and experienced pitch consultant will work with you to develop the right solution for your defined needs.

Appointing a competent pitch consultant

The selection of the right consultant for sports turf and sports drainage work is as critical as getting the right architect to design the clubhouse or sports hall. Choosing the right consultant will save time and money and will bring real added value to the design, construction and maintenance of the

pitch over many years. See Appendix 1 for further guidance on selecting the right consultant for the project and Appendix 2 for the schedule of services that a competent pitch consultant should be able to provide.

User profile

Information regarding types of use and users should be compiled from the outset of any project:

- Identify the sports to be played month by month so that the number and size of pitches required can be determined.
- Expected level of user performance, for example, local league, regional or national
- Each sport has its own set of PQS which constitutes the minimum acceptable performance criteria (e.g. drainage capacity, hardness etc.) for different levels of the game (e.g. local, regional or national). These are essential for the effective design, construction, maintenance and long-term sustainability of the surface.
- Likelihood that the facility will be used for training to determine the total anticipated number of hours of play per pitch per week.
- Number of times per week for each activity, duration and whether for junior or senior use
- Will artificial sports lighting be required?
- Is there a requirement for phased development which will affect the number of pitches available during the proposed construction period? Will there be a need to identify alternative facilities?
- Will there be any non-sport use during the year, for example, as temporary car parking or a venue for a local gala?
- What long-term resources will be available to maintain the playing surface?
- How much money is available to carry out the necessary work?

Additionally it is important to take into account of the likely long-term developments in sport that might affect facility use, for example, the introduction of mini-games or the move from the winter to the summer season. Consider also the need to introduce facilities for additional sports, for example, a cricket square located between winter games pitches.

Location of playing surfaces

The shape and contours of the site will influence the location of the playing areas. This is particularly true for natural turf playing surfaces where the need for well-drained areas is paramount.

Careful consideration must be given to the specific requirements of the playing surfaces and the supporting ancillary facilities. It should not be assumed that because an existing facility, a pavilion or pitch, for example, is located in a certain position that it should stay there. Careful design will be rewarded by efficient layouts that are often easier and more economic to construct and maintain.

When analysing the suitability of a site ensure that:

- There is sufficient space for the proposed facility and space for future expansion.

The size and layout of pitches should take into account the level of play, necessary safety margins and optimal orientation.

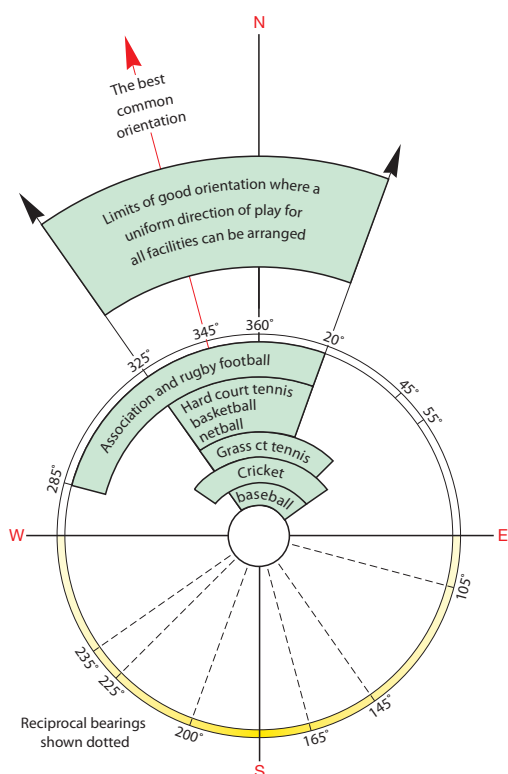

Recommended pitch orientation

(Goal to goal, wicket to wicket, or baseline to baseline based on the National Playing Fields Association's pitch and orientation diagram, but amended to take account of ECB guidance).

- There will be adequate space for car parking based on local authority requirements and for any potential overflow.
- Access is available for service and emergency vehicles.

Requirements for proposed activities

Check all dimensions with relevant Sport NGB for relevant standards / levels of play.

Each sport will have specific dimensions defined by the relevant national governing body (NGB) or league. These requirements will not only define the size of the playing surface but will include 'safety margins' around it. Additionally, they may define relationships to other facilities such as a changing room or pavilion⁴. Other considerations include:

- Facilities and viewing positions should be orientated to avoid low sun angles.
- Ensure that there are no conflicting relationships between uses. For example, adjacent to a cricket pitch, do not locate an activity immediately behind the bowler's arm.
- Consider issues relating to access and security; visibility, lighting, roads and footpaths.
- Ensure adequate car parking provision can be made available.
- New developments will require planning permission involving the submission of detailed drawings. Car parking, access and potential effects on neighbours will be considered as part of the application.
- Protection of users from inclement weather should be provided.
- Requirements for temporary roads providing access for machinery during construction and for maintenance equipment that may be required later⁵.

⁴ See separate Sport England Design Guidance Note 'Pavilions and Clubhouses'.

⁵ See separate Sport England Design Guidance Note 'Car Parking and Landscaping Design'.

Feasibility study

A technical appraisal of the site must be carried out by a competent, independent professional.

The appraisal must take account of the expected usage and associated implications for the design and construction of the playing areas, and identify any potential restrictions or difficulties in developing the site, including the need for any further investigations. The study report should include outline proposals for the facilities with outline costs, an indicative programme for the proposed works and an estimate of when the facility will be available for play.

This should also indicate likely maintenance operations and associated costs and the capital cost of purchasing the equipment necessary to cover this essential work.

Site surveys

For most projects a detailed survey, with levels, will be required to establish the key features of the site. The areas for consideration are detailed below:

- The local climate and excess winter rainfall must be considered to evaluate the impact on the need for drainage and irrigation. For projects involving drainage, commissioning a consultant with experience of natural turf drainage (as opposed to civil or agricultural drainage) is essential.
- The topography of the site will determine the need for any level adjustment in order to comply with appropriate PQS. Sites with significant slopes will need to be regraded by cutting and filling the subsoil after stripping off the topsoil to produce playing surfaces with acceptable gradients.
- Where drainage improvements are required, a positive outfall should be identified into which water from the site can be discharged. Soakaways can be used in some situations, however these must be designed in accordance with recognised procedures.
- The need for irrigation requires assessment along with that of potential water resources and storage.
- The condition of physical structures, such as retaining walls and fences.
- The location and type of services that may affect the construction.
- Planting, including the location and condition of trees and whether they are covered by tree preservation orders (TPO).
- Site boundaries / perimeters: condition and ownership.

Undertake a detailed site survey. Key considerations include local topography, ground conditions and provision of effective drainage outlets.

Ground conditions

The particular ground conditions of the site should be fully understood and issues to consider include:

- The general underlying geology of the site including the type of soil and underlying rock formations. This information can often be obtained from geological maps, but needs to be corroborated during a detailed site investigation.



An investigation of the infiltration on the site is necessary to inform the design of the natural turf facilities

- The type and depth of the topsoil should be assessed by professionally qualified consultants with a detailed knowledge of sports turf.
- The potential for soil shrinkage to occur may influence the development options available.
- The site's natural drainage capacity including the permeability of the soil and subsoil should be assessed. Reliable information must be obtained from on-site sampling and associated laboratory analysis.
- The history of the site should be investigated to establish whether the site has been contaminated by tipping or other industrial uses.
- All reclaimed sites should be treated with caution. Former household refuse tips are vulnerable to localised settlement and the

production of hazardous gases. Glass and other debris in surface soils are hazardous to players, while the presence of asbestos, heavy metals or toxic chemicals can give rise to further complications.

- Investigations for the site can be carried out with an environmental search company to provide data on the site history and the possibility of soil contamination. This should be followed up by a detailed site evaluation if required.
- It may be necessary to engage a specialist company to undertake an assessment of contaminated materials on site.
- Rainfall levels will affect the performance of all surfaces. Areas of high prevalent rainfall will need higher standards of construction and drainage.
- Drainage design should also take account of recent climate trends and future projections.
- The scheme design must include the design, calculations and specification of a sustainable outfall or soakaway system (see section on Planning and Consents).

The pitch drainage system must be designed by a consultant with a detailed knowledge of sports turf drainage.



The condition of underlying soil needs to be assessed by a competent consultant

On some sites, industrial waste and possible contamination will require specialist advice on how this could impact on the development in terms of user safety, environmental protection and safe disposal



Red mottles in clay can indicate seasonal water logging and the need for land drainage

- The designer must prepare a fully specified maintenance schedule to ensure the surface is maintained to promote good grass establishment.
- The report must include recommendations for appropriate maintenance equipment and any special training that may be required to adequately maintain the pitch.

When planning a natural turf surface, it is essential to take account of the specific sports turf performance applicable (see Appendix 4) along with future maintenance requirements (see Appendix 5).

Key performance criteria for natural turf sports surfaces include:

- ***Grass height (mm)***
- ***Broad leaved weeds***
- ***Thatch (accumulation of organic matter)***
- ***Hardness***
- ***Water infiltration rate***
- ***Evenness***
- ***Slope***
- ***Ground cover.***

See Appendix 4

Planning and other consents

The consents required and the information needed to support any applications should be considered at the early stages of a project to avoid delays or abortive work. The planning authority should be consulted to understand the detailed requirements:

- For new pitch developments, or for demonstrating compliance with planning conditions, details and supporting information will have to be submitted for Planning Approval. Different levels of information are required for an 'Outline' or a 'Full' planning application and in some situations consultation with Sport England⁶. Site investigation and the feasibility study work will be needed to demonstrate that the new or improved pitch will be able to cope effectively with the proposed programme of use.
 - The planning officer and Sport England will use this guidance note and the PQS for the relevant sports to demonstrate that the new construction / the proposed pitch improvement works will provide a pitch that is suitable and will maintain its performance in the long term.
 - New developments will be screened by the Local Planning Authority to determine if a full Environmental Impact Assessment (EIA) is needed.
 - Information of primary environmental importance is identified through a scoping opinion obtained from the Local Planning Authority based on a preliminary review of the development proposals.
 - A full EIA usually includes the following topics:
 - Ecology
 - Landscape
 - Water quality / hydrology
 - Traffic and transport
 - Archaeology / cultural heritage
 - Land use and clarification
 - Social and economic factors.
- Legislation is in place to protect particular habitats, birds and animals and this legislation must be considered when developing designs for the site.
 - An Environmental Management Plan may be required, identifying potential environmental impacts and how these will be mitigated or managed.
 - Consent for drainage outlets may be required. This will be obtained from the relevant local authority and / or the Environment Agency.
 - The need to control flooding in watercourses and urban drainage systems is now paramount and in most cases there will be a requirement to follow the principles of Sustainable Urban Drainage Systems (SUDS). This will control the flow of drainage water from the site and appropriate designs, calculations and specifications will need to be prepared and approved. This can be very expensive in terms of capital and maintenance costs and therefore it is essential that they are designed by properly qualified and experienced consultants.
 - In England, for projects costing more than £300,000, a Site Waste Management Plan (SWMP) will be required setting out how materials will be managed to reduce waste during the project.

See Sport England web site for further information on planning applications.

http://www.sportengland.org/facilities_planning

Further information on making planning applications can be found on www.planningportal.gov.uk.

⁶ Planning applications that affects a playing field should be referred by the local authority to Sport England for comment. It is strongly recommended that Sport England is consulted prior to submitting an application.

See separate Sport England publication 'Making a planning application - A guide for sports clubs'.

3.0 General Pitch Construction

Contracts and contractors

This section discussed the general construction issues that arise in the creation of a natural turf pitch.

The procedures and arrangements for engaging contractors and supervising the contract are important as they can ultimately influence the success of the sports facility.

Having established the requirements for the site, the information should be set out in the form of a tender document. This should include a specification⁷ with drawings and sufficient information to enable the contractor to price the work as specified. Alternatively, the performance requirements for the work can be set out so that the contractor can develop a scheme on a 'design and build' basis.

The document should clearly define the conditions of contract to avoid any confusion regarding the work to be carried out, the programme and the arrangements for payment. Standard contract conditions are available to which specific requirements for the project may be added.

The tenders received should be properly assessed before awarding the contract. This may involve interviewing contractors for larger projects to ensure that all aspects of the project have been covered and costs included.

Proposed materials should be tested by a competent consultant and approved laboratory before work commences to ensure that they comply with the specification. Further testing of materials should be carried out during the works. An effective programme of monitoring the workmanship will ensure that good standards are achieved. It is very difficult and costly to rectify problems afterwards.

The work should be tendered to experienced contractors with a proven track record in sports turf development.

Clearly specified works and a well defined contract implemented by a competent contractor, combined with effective supervision and turf maintenance will eliminate many problems experienced with new turf sports facilities.

Site clearance

The general construction processes are set out in the following paragraphs:

- Site clearance
- Adjustments of levels
- Drainage - general principles
- Cultivation and seeding
- Early maintenance
- Maintenance equipment.

Before any clearance work can be carried out it is essential that all necessary consents are in place and that all measures to protect habitats, birds and animals have been carried out.

The site must be cleared of rubbish, rough grass and all unwanted hedges, trees and scrub before works start. Tree felling must only be done where absolutely necessary and after all consents have been obtained. If any waste is to be removed to a tipping facility it will require characterisation to establish the Waste Acceptance Criteria (WAC). This will govern the location of a licensed tipping facility suitable for the materials and the cost of disposal.

Adjustments to the surface levels

In general it is preferable to minimise the extent of earthworks and to carry these out under dry conditions, to reduce the potential for soil compaction.

A constant slope is desirable on all pitches to assist in shedding surface water in periods of heavy rainfall. The slope will also help drainage in areas such as goal mouths where heavy wear and tear would be expected. The actual gradient of the slope may depend on a number of factors including the overall drainage strategy for the site, specific features around the pitch and general topography.

Generally, depending on the standard of facility required, the playing surface should be no steeper than 1:80 - 1:100 along the line of play and 1:40 - 1:50 across the line of play.

Recommended maximum gradients are given in Appendix 4 (*Performance Quality Standards*) and with pitch construction options in Section 4.

⁷ See 'Model Contract Specifications' that are downloadable from the Sport England website.



Many sites require major regrading of levels

Where the surface is slightly uneven and the overall gradient is acceptable it may be possible to prepare a smooth surface by moving soil from slightly higher ground to lower areas with a blade grader. This can often be supplemented by spreading topsoil recovered from the building or car parking areas.

There must be a minimum of 150 mm 'firmed' depth of topsoil to promote and sustain a healthy grass sward. That is to say an expanse of short grass.

On steeper sloping or very uneven sites where extensive adjustment is necessary major regrading will involve altering the levels in the subsoil.

The first stage is to scrape off the existing topsoil cover and retain for eventual respreading. Avoid mixing the topsoil with the underlying subsoil. The levels are then adjusted in the subsoil using the surplus soil cut from the high ground to fill lower areas. In some situations imported fill material may be required to build up low areas.

Filling must be done in consecutive layers not exceeding 250 mm. Each layer must be adequately consolidated to avoid subsequent settlement. The final formation must be trimmed smooth to the required level before replacing the topsoil.

On completion of the grading operations the topsoil is replaced to a uniform depth to produce a finished surface that marries in with the surrounding ground levels.



To create a level surface, it may be necessary to strip the topsoil, regrade the subsoil, and replace the top soil



Slopes of surrounding banks should not exceed 1 in 3 to facilitate mowing

It should be appreciated that soil levelling will always have some impact on the soil structure and so it is essential to minimise this by conducting earthworks only under dry conditions. Stockpiling the soil for long periods should be avoided and the height of the stockpile should be kept to a minimum if possible. As a guide, the maximum height should be no more than two metres. It may be helpful to firm the surface of the soil to facilitate the shedding of surface water.

Where possible, the best topsoil should be recovered for the playing areas and care should be taken to prevent contamination with stones or rubble from any building work.

In some cases a high stone content in the soil, particularly sharp stones, may mean that the soil should be screened to ensure that a safe playing surface can be prepared. This will increase the tendency for soil compaction to occur and remedial action will be needed after respreading the soil.

In general, the height and gradient of banks around the playing areas should be kept to a minimum wherever possible. On steeper sites it may be necessary to take additional precautions to ensure that the banks are stable. This may involve the use of retaining structures and the advice of a qualified civil engineer may be required.

Any surrounding embankments should be no steeper than 1:3, for safe and effective maintenance.

In many locations, it is possible that rock or unstable ground may be encountered where a deep cut is necessary. This should be anticipated in the early design stages and an appropriate design prepared.

Where high banks are essential, consideration should be given to the safety of users and the maintenance required. Additional fencing may be needed along the top of a high bank.

For larger banks, a catchwater drain may be required to prevent any 'run-off' affecting adjacent playing and spectator areas.

Drainage - general principles

Consider the permeability of the soil and the requirements for the drainage systems and the long term maintenance of good drainage.

In some instances, particularly where the indigenous soil has a high sand content, the natural drainage capacity of the site soil may form an effective basis for a good playing surface, although this is unusual. In most cases the soil is less permeable and so an effective drainage system must be provided to prevent deterioration of the playing surface and to ensure that the required standards can be met. The natural contours of the ground may be able to assist the drainage system and these should be carefully



The rate at which water moves through the surface can have a major impact on the quality of the facility



Adjacent water course can provide a convenient means of achieving efficient drainage provided that a 'land drainage consent' can be obtained

studied against the recommended slope requirements for the pitch. See Appendix 4 - Performance Quality Standards.

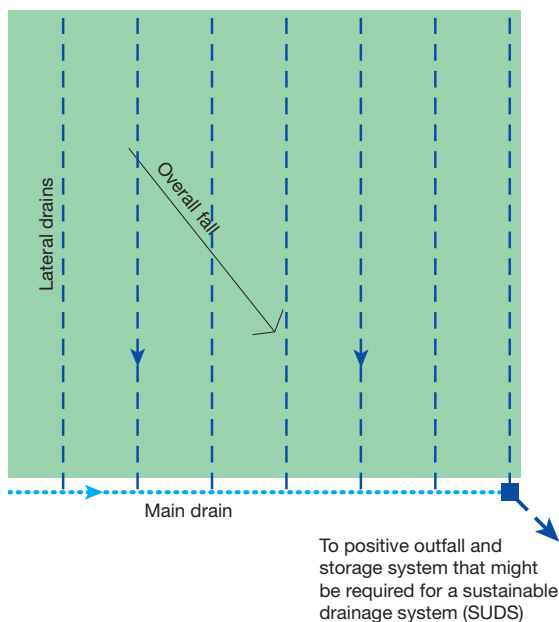

A typical pipe-drain layout for football and rugby pitches with main drain outside the playing area. The overall slope of the pitch assists the new drainage system

The need for well drained pitches with a smooth even surface is paramount.

At the feasibility stage it is essential to consider the effect of 'run-off' from adjacent areas or new embankments.

The capacity of surrounding drainage infrastructure must also be considered and, in particular, whether there is a restriction on the drainage discharge from the site. It may be necessary to carry out infiltration tests so that an effective system of soakaways or an attenuation facility to control the flow can be designed and constructed.

The design of the drainage system must take account of the intended frequency and standard of use.

The intensity of drainage infrastructure installed may vary for different pitches on the same site



Drain installation normally requires the use of specialist trench machinery fitted with laser guidance

according to the nature of use. The main pitch, where the most important matches are played at specified times, will require greater reliability and therefore the installation of a more intensive drainage system.

An effective pipe drainage system is fundamental to all sports turf drainage. On pitches this may be supplemented with a secondary system of slit drains or sand grooves. This will provide a more intensive system to offer more rapid surface drainage.

These systems can be installed with specially designed equipment to reduce the damage to the soil surface or existing turf. Backfilling trenches can also be carried out with purpose designed equipment with low ground pressure tyres or on tracks to reduce the impact of carting heavy aggregates, such as sand and gravel.

Drainage systems should be designed to intercept the movement of water down the main slope of the site. The layout of the systems should be as simple as possible with good access points provided for inspection and maintenance such as removal of silt accumulation in silt traps and clearing blockages in pipes by rodding or jetting.

The permeable trench backfill material should be carefully specified to ensure that it meets the required drainage performance criteria and that all materials are hydraulically compatible (i.e. an abrupt change in the range of particle sizes contained within adjacent layers can impede water movement). Drain trenches and slits should be wide enough to ensure that water can flow satisfactorily through the permeable fill to the drains. It is also essential that water flow into permeable drain trenches is not impeded by inadvertent capping over with less permeable material.

Very often, there is a requirement to attenuate drainage water before it reaches its final outfall (e.g. ditch, river, or connection to the surface water drainage scheme). These systems may comprise the following:

- Attenuation basins, ponds or lakes
- Grassland swales
- Shallow or deep-bored soakaways.

The design of such systems is site specific, and typically, will be subject to statutory approval from the Environment Agency, who will require supporting calculations to demonstrate its compliance to their requirements⁸.

For recommended methodologies for calculation of drain flow and greenfield run-off rates see *ADAS Reference Book 345*: ISBN 0 11 241515 6 Institute of Hydrology Report No. 124 – ‘*Flood estimation for small catchments*’.

Cultivation and seeding

The preparation of the soil or rootzone material (i.e. a mixture of sand and soil) is critical to the standard of the finished playing surface whether it is for a bowling green, football pitch or cricket field.

The surface should be smooth and even at the designed gradient with a fine tilth for good seed germination, emergence and establishment.

Major nutrient deficiencies can be rectified more easily at this stage by incorporating the fertilizer through the topsoil. The type and quantity of fertiliser should be based on soil analysis to ensure that the nutrient levels are satisfactory to promote good growth.

For football and rugby pitches it may be advisable to incorporate sand into the surface of the pitch to improve infiltration and to improve surface playability.

Seeding should be carried out at the optimum rate to promote good sward density. An appropriate mixture of seed should be selected for the type of use with reference to the Seed Booklet produced by the STRI and the British Society of Plant Breeders.

⁸ See design and construction of such systems at <http://www.ciria.com/suds>.

General maintenance

Performance Quality Standards (PQS) provide a benchmark for assessing the efficacy of maintenance operations in terms of achieving and maintaining the quality and performance of natural turf sports surfaces.

Refer to Appendix 4 for selected key PQS.

If weeds, pests or diseases are evident, herbicides and pesticides should only be applied according to manufacturer's recommendations, and by qualified personnel holding the relevant certificate issued by the National Proficiency Test Council (NPTC). www.nptc.org.uk

As soon as the grass has started to establish, a rigorous programme of aftercare must commence with a sequence of operations to encourage the development of a strong dense sward.

This must continue until the surface is ready for play. The turf will continue to mature and the ongoing maintenance must take this into account.

A fully specified maintenance schedule must be produced by a competent Consultant and acted upon. Consider the frequency of mowing, aeration, irrigation, seeding, use of fertilizer, and weed/pest control.



During periods of dry weather, it may be necessary to irrigate newly seeded areas

The management regime for a new facility is different to that required for old, well established turf:

- Regular mowing is fundamental to the maintenance of surface quality. Frequency of mowing will depend on the time of year and will vary according to the location of the site.
- To aid growth and recovery, as well as to maintain good presentation, fertilizer must be applied at the optimum rate and at appropriate times. The exact requirements must be determined by soil analysis.
- Aeration, the process of increasing the availability of air to soil and roots, is essential to relieve compaction and maintain surface drainage. Additionally, it promotes strong root growth and sward resilience.
- Irrigation may be required to aid grass growth during dry periods.
- Regular seeding is necessary to repair damaged and weakened areas of turf. Full grass cover is essential to maintain consistency and to prevent weed invasion.
- Ongoing preventive measures are required to protect the playing surface from pest damage.

Specific maintenance requirements for each type of playing surface are detailed in the appropriate sections that follow.

Maintenance equipment

There are two main approaches to the provision of maintenance resources; to either employ staff and purchase own equipment or to engage a turf maintenance contractor.

It is possible to hire specialist machinery used occasionally to supplement the basic equipment. Hiring equipment and engaging contractors will save on the initial capital cost. It will also reduce problems associated with maintaining the machinery in a safe and efficient condition. The appropriateness of this method will depend on the size of the facility and the availability of skilled local contractors with the appropriate equipment. Factors to be considered are presented in Appendix 5 - *Maintenance resource check list*. It may be possible to purchase some maintenance materials and achieve savings but this will depend on the purchasing power of the contractors.

Appropriate timing of maintenance operations in relation to the weather and ground conditions is important for the effective maintenance of the turf. Where contractors are appointed for maintenance, it is essential they are contracted to achieve the performance standards with all operations carried out at the appropriate times and under the right conditions. It is paramount this is taken into account by grounds staff and contractors.

In practice, a combination of these approaches may prove to be the most economical and effective. The cost of maintenance will vary considerably according to the method of procurement and the availability of contractors and materials.

Good maintenance practice is regarded as the most important factor influencing the success of a new pitch development⁹.

Designers should consider maintenance and capital cost together.

A budget should be prepared to provide for new equipment, annual servicing and the replacement of worn out implements to ensure the quality of the playing surface is maintained.

Create adequate, secure storage provision for maintenance and sports equipment.

Facilities must be provided for the secure storage of equipment on site with space for materials that are used for maintenance such as top dressing sand or cricket loam.

Provision must be made for the safe storage of pesticides, all other chemicals and fuels conforming to current legislation. Additional information on pesticide storage is available in the Agriculture Information Sheet No. 16 available from the Health and Safety Executive¹⁰.

Protective measures must be adopted to prevent the discharge of any contaminated drainage water to public sewers or watercourses. To this end, care must be taken to ensure that waste materials (e.g. grass clippings, engine oil etc.) are stored appropriately prior to disposal.

⁹ SAPCA Code of Practice for Design, Construction and Maintenance of Natural Turf Pitches.

¹⁰ www.hse.gov.uk.

4.0 Football and Rugby Pitches

This section discusses in more detail the use, design, configuration, construction, establishment and ongoing maintenance of football and rugby pitches. The summary table on page 27 shows estimated costs, maintenance and the advantages and disadvantages of various construction techniques.

Traditionally, football and rugby union are played on a seasonal basis when grass growth is minimal and soil very wet. Frequently grass cover is worn at the beginning of winter and quagmire conditions can develop in high wear areas of the pitch such as goalmouths and centre circles. As a result players are unable to experience a satisfactory quality of game.

The pressure to get matches played means they often take place at inappropriate times, for example, during heavy rain. Frequently, maintenance routines during and after the season are unable to restore the pitch to an adequate state for quality play to take place. A vicious circle of deterioration sets in as a direct result of poor drainage and compaction of the playing surface.

Designing for likely use

Performance Quality Standards (PQS) provide a benchmark for the quality and performance of natural turf sports surfaces, as well as to assist with their management. These constitute the minimum acceptable performance criteria (e.g. drainage capacity, hardness etc.) for different levels of the game (e.g. local, regional or national) and are an essential mechanism for the effective design, construction, maintenance and long-term sustainability of the surface. Refer to Appendix 4 *Performance Quality Standards* for PQS relating to football and rugby.

The majority of playing surfaces require a designed drainage system to provide satisfactory playing conditions throughout the playing season.

Consider the frequency and intensity of use. A hard wearing seed mixture would be suitable for pitches with winter use.



Good surfaces maintain safety levels and maximize quality of play

Poor construction, lack of effective maintenance and overuse of the pitch will, eventually, lead to poor drainage and unacceptable playing conditions. It is essential that pitches are designed taking into account the estimated intensity of use.

Players under the age of 15 are judged to inflict about half the damage to a pitch than their more senior counterparts. Therefore, a pitch used predominantly by juniors can accommodate approximately twice the capacity of one used solely by more senior players.

The pattern of use must be taken into account when designing a pitch. Where use primarily takes the form of a large number of games played during weekends with little play during the rest of the week, demand cannot be staggered to make best use of a single 'high specification' pitch. In these circumstances, general upgrading of pitches using sand grooving or slit draining and sand amelioration (i.e. the incorporation of sand into the surface to improve playability - see Section 4 *Pitch Construction* pages 21-27) would be more appropriate than the creation of a single 'premier' pitch.

Pitch configuration

The layout of the pitches should be considered carefully to maximise the use of the available space and the future flexibility. Pitch marking with safe clearances and ball stop fencing where appropriate should meet the current recommendations of the relevant sports NGB.

The location of spectators needs to be considered to avoid interference or damage to adjacent playing surfaces. This can be a particular problem if football /rugby pitches are located too close to a cricket square.



Laser-guided grading of a pitch

Pitch construction

Pitch construction falls into six main categories according to the system of drainage used:

- Type 1: Undrained
- Type 2: Pipe drained
- Type 3: Pipe drained with mole drains
- Type 4: Pipe drained with sand grooves
- Type 5: Pipe drained with slit drains
- Type 6: Topsoil and drainage layer
- Type 7: Suspended water table.

Increasingly the 'Type 4: Pipe drained with sand grooves' system is seen as the most suitable for the creation of good quality pitches as it is cost effective to construct and produce a pitch that, in most cases, is also cost effective in terms of maintaining the specified sports turf performance criteria. Sand grooving systems are now widely recognised as being preferable to the more traditional slit drain systems which are prone to premature failure due to limited resources of facility operators in terms of irrigation and sand top dressing requirements.

It should be noted that undrained and even pipe drained solutions are unsuitable for clay soils.

In some situations it may be appropriate to adopt different standards of drainage for different pitches on a single site. Key matches played at specific times on the main pitch may require a more intensive system of drainage to provide the reliability in wet conditions. Pitches for more routine use may not be subject to the same intensity of use and it may be possible to adopt a different approach to the development of these pitches.

It is essential to take professional advice from a sports turf specialist to ensure that the quality of the pitches is not compromised and the chosen solution is sustainable.



Type 1: Undrained

There are few situations where pitches of this type will provide a sustainable, quality playing surface. They are likely to be of use only on naturally well-drained soils. For example, sand, well-structured topsoil over gravel, limestone or chalk and where there is sufficient gradient to assist in shedding excess surface water.

There are very few situations where undrained pitches will be suitable.

Type 2: Pipe drained

In the past, simple pipe drainage has been the most frequently used system. However, unless the site has reasonably free-draining sandy soil or sufficient gradients to remove large quantities of water by surface shedding, pipe drainage alone is often inadequate and the pitch can be susceptible to wet weather cancellations. The system requires:

- Corrugated plastic pipe lateral drains that are usually installed at 5 - 10 m centres at a depth of 450 - 600 mm below ground level.
- Increasingly twin wall pipes are being used for main drains providing a more rigid pipe with better flow characteristics.
- All drains must be laid with a steady fall with the pipe diameter and gradient designed such that the design flow rate can be achieved. Falls in the region of 1:100 are common.
- A positive outfall must be provided in the form of an existing watercourse or surface water system or an effective soakaway system should be constructed. This will have to comply with requirements imposed by the drainage authority or Environment Agency.

When the drains have been laid trenches must be backfilled with porous material to ensure that the high percolation rates necessary for effective drainage are achieved.



Installing pipe drainage in a new pitch

Predominantly single-sized, hard, angular gravel or broken stone within the range 6 – 10 mm must be used as backfill. This should be brought to within 150 – 200 mm of the surface.

The trench backfill is often ‘capped’ with a 50 mm ‘blinding layer’ in the form of coarse sand or fine grit to prevent infiltration of the topsoil. The trench is backfilled to ground level with preserved topsoil or an imported, permeable sandy rootzone material.

Given reasonably permeable soils and good management, fairly good playing surfaces can result. However, in many areas of the UK this method is not suitable, given the slowly permeable nature of the indigenous soil. This system is therefore generally only suitable for situations where the indigenous soil is permeable but is affected by shallow groundwater levels. The lateral drains serve to ‘pin down’ the water table. It is therefore essential that a competent consultant is commissioned to establish the optimal drain depth and spacing to ensure that wet strips do not occur between adjacent drain runs.

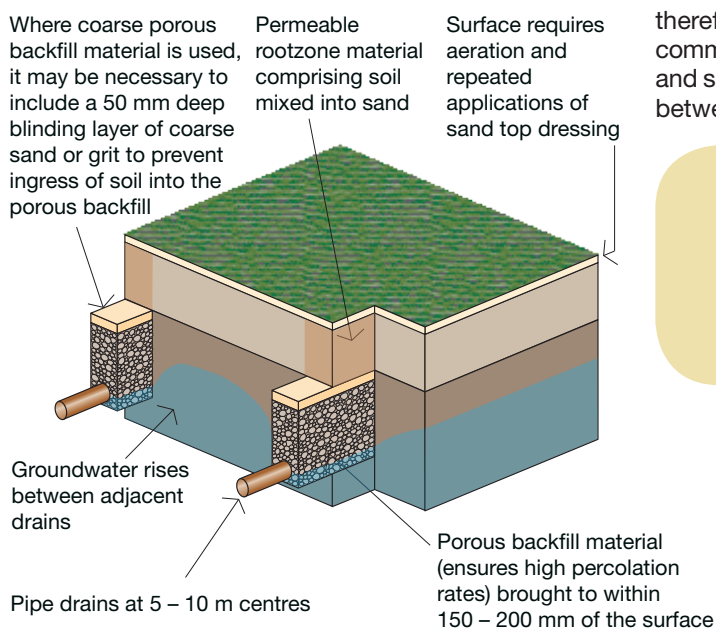

Pipe drained systems alone are only suitable for free-draining sandy soil conditions.

Pipe drainage construction on cultivated topsoil

Type 3: Pipe drained with mole drains

Mole drainage potentially offers a very cost-effective solution to surface water drainage. This system comprises pipe drains installed at 5 - 10 m centres in combination with mole drains installed at approximately 1 m centres. The mole drains are created by a tractor-mounted mole plough which creates stable channels within the clay subsoil that are connected to the surface through fine fissures and by the leg slot, and that also connect with the permeable backfill over the pipe drains.

For this approach to work, the clay content must be sufficiently high (> 30%) and the clay must be of the correct mineralogy such that it does not disperse when saturated. Soil samples should be tested to confirm the suitability of this approach. However the following should be noted:

- Mole channels have a finite operational lifespan and typically, re-moling will be required every three to five years.
- Some clay soils suffer significant shrinkage on drying and there is a risk of surface cracks developing might make the pitch too dangerous to play on. This is most likely to occur during the first summer after mole drainage installation.
- The risk of large surface cracks developing can be mitigated to some degree by installing closely spaced linear slits (typically at 260 mm spacing), parallel to the mole drains so that numerous small, but safe, cracks develop.



Cross-section through pitch showing a mole channel and leg slot



Mole plough

Mole ploughing a pitch

- Successful mole drainage is dependent upon a number of interacting factors (e.g. clay stability, clay plasticity, mole channel depth, mole plough size and mole plough set-up). It is therefore strongly recommended that advice is sought from a sports turf consultant experienced in mole drainage.

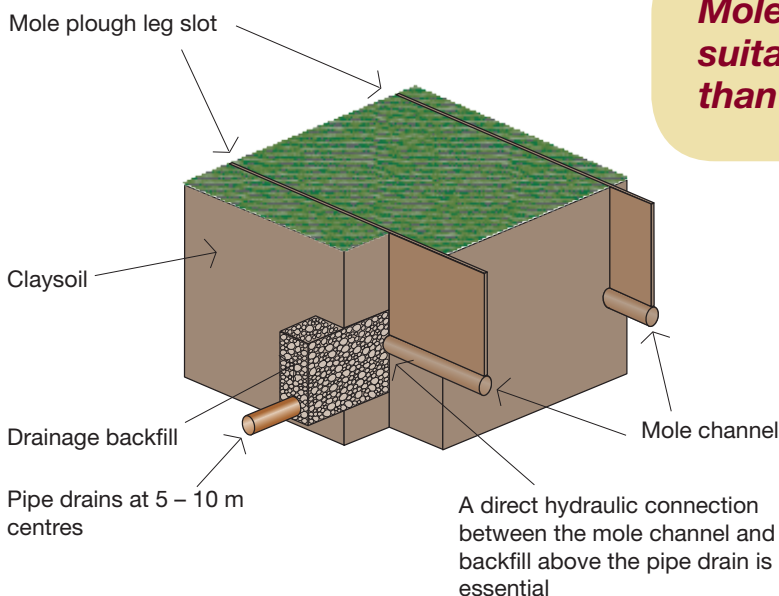

Mole drainage construction on cultivated topsoil

Mole drains are only suitable for soils with more than a 30% clay content.

Type 4: Pipe drained with sand grooves

This type of construction is now becoming the most frequently used type of drainage system where an effective pitch construction is required, and provides an intensive and effective method for intercepting water from the pitch surface. It is cost-effective to construct and maintain as well as reducing the potentially serious problems of shrinkage associated with the pipe drained with slit drainage form of construction.

The pitch construction is similar to that of the pipe drained pitch above with the addition of a series of sand grooves, approximately 150 mm deep and 20 mm wide, introduced by a machine at a spacing of 260 mm. These grooves are forced into the soil with a tine rather than being created by excavating a narrow trench, and can be filled with sand or fine grit. It is essential that the sand grooves connect efficiently with the permeable backfill of the pipe drainage system below.

Heavy top dressings of suitable sand are essential for the successful construction and management of pipe drainage and sand grooved pitches:

- The dressing should be applied immediately after installation of the sand grooving and subsequently reapplied as part of routine maintenance works in the close season. This process will be necessary for at least three to five years following installation.



Sand grooves installed at 260 mm centres

- Each application of dressing should be in the region of 60-100 tonnes, depending on the size of pitch.

Pipe drainage with a secondary drainage system is considered to be the most suitable type of construction for the creation of good quality pitches that can meet the necessary PQS.

Where coarse porous backfill material is used, it may be necessary to include a 50 mm deep blinding layer of coarse sand or grit to prevent ingress of rootzone into the porous backfill

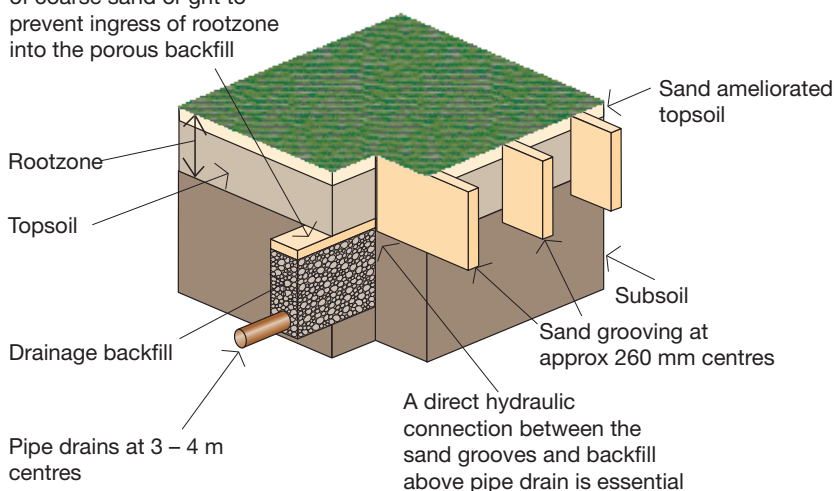

Pipe drainage construction on cultivated topsoil with supplementary sand grooving

Type 5: Pipe drained with slit drains

Supplementary slit drains will significantly improve the removal of water into pipe drains. Basically the construction mirrors that of a pipe drained system with the addition of a series of narrow, commonly 50 mm wide, sand and gravel filled trenches excavated across, and into the porous backfill of the lateral drains. Slit drains are typically 250 - 350 mm deep and installed at 0.5 - 2.0 m spacing.

Heavy top dressings of suitable sand are essential for the successful construction and management of slit drained pitches.

The dressing should be applied immediately after installation of the slits and subsequently reapplied as part of routine maintenance works in the close season. This process will be necessary for at least three to five years following installation.

Each application of dressing should be in the region of 60 – 100 tonnes, depending on the size of the pitch.

A drawback of slit drains is that they can become capped and sealed over with topsoil, which can



Combined pipe and slit drainage will significantly improve the drainage of most pitches

render them ineffective. Also, slit drains installed in clay soil can be prone to settlement in dry weather due to the clay shrinking on drying. They therefore require frequent topping up, particularly during the first year following installation, to prevent an uneven and possibly dangerous surface developing. It is for this reason that 'Type 3' constructions, comprising narrowly spaced sand grooves, are becoming the industry standard for improving the surface drainage of pitches.

Adequate maintenance is essential in order to produce and maintain a vigorous, dense sward.



Where coarse porous backfill material is used, it may be necessary to include a 50 mm deep blinding layer of coarse sand or grit to prevent ingress of rootzone into the porous backfill

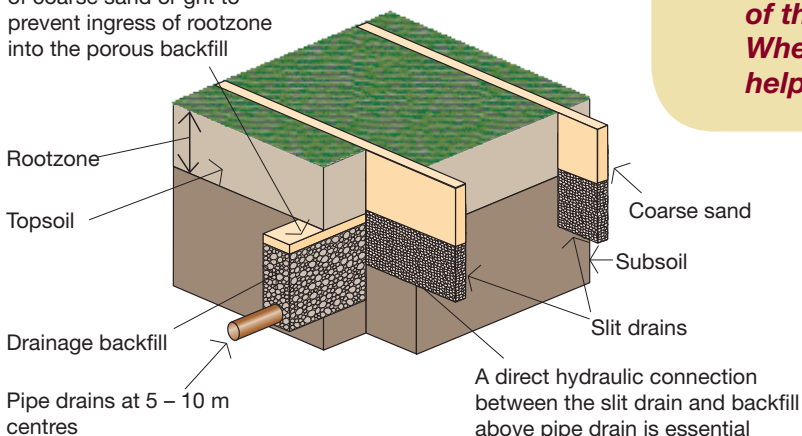

Pipe drainage and slit drainage construction on cultivated topsoil

It should be noted that pipe drained surfaces with slit drains might:

- ***Be uneven during the first season.***
- ***Settle in the summer months due to shrinkage in clay soils. These must be monitored and filled with sand to maintain the safety and quality of the surface and the effectiveness of the drainage system. Where available, irrigation will help to reduce this problem.***

Type 6: Pipe drained with topsoil and drainage layer

In some cases, particularly on reclaimed land such as former school buildings, it may be appropriate to develop pitches on a drainage layer or grit raft combined with a soil growing medium rather than a sand based rootzone material as used in the suspended water table construction (see Type 7).

This approach can produce a higher standard of playing surface but with less reliance on high rates of fertilizer or irrigation compared with a sand-based pitch profile (e.g. Type 7).

The method can be used effectively where the underlying subsoil materials are unsuitable for a conventional pipe and slit system.

It is essential to include a secondary system to connect effectively through the soil to the grit layer.

The design of the profile and the materials used are critical to the successful development of the pitch and depend on the soil available.

As with all pitches, the need for good maintenance is essential and irrigation should be included.

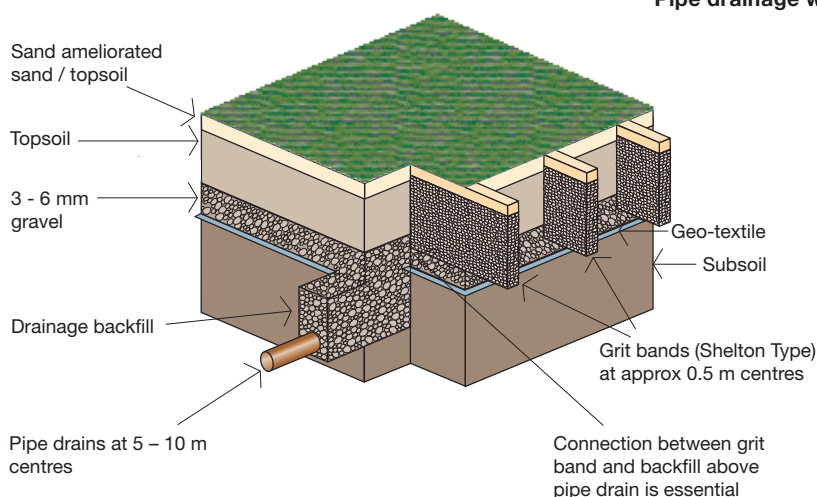

Pipe drainage and slit drainage construction on grit raft

Type 7: Pipe drained with suspended water table

This type of construction forms the basis for very high standard pitches and is very demanding in terms of management, particularly with regard to fertilizer and irrigation requirements. The more efficient the drainage system, the greater the need for effective irrigation and feeding. This method is appropriate for a high standard of pitch where the timing of matches is critical or for training at a high level, e.g. for a professional football or rugby club.

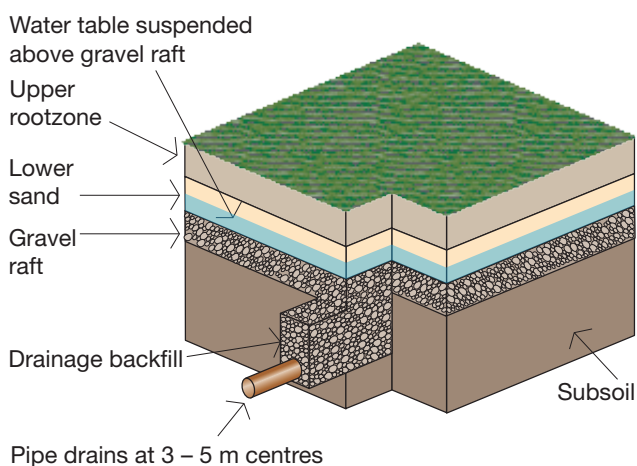

Pipe drainage with water table suspended above gravel raft

Table 1 Summary of pitch drainage types

Pitch type	Adult weekly use ¹¹ (hours)	Comparative capital and maintenance costs for different pitch types based on a senior football pitch (£) (Ex. VAT)		Maintenance	Advantages	Disadvantages
		Construction and / or Improvement works ¹² (including 12 months maintenance)	Ongoing annual maintenance costs ¹³			
1	Undrained	Under 2	15,000 up to 45,000 (Regrading)	5,000 – 10,500	Aeration and sand dressing when conditions allow.	Low capital cost. Likely to be suitable only in naturally well-drained soils.
2	Pipe drained	2 - 3	40,000 (Drainage) up to 70,000 (Drainage + regrading)	5,000 – 10,500	Aeration and sand dressing when conditions allow.	Low capital cost. Drainage intensity can be increased later. Can be very effective in controlling shallow or rising groundwater. Susceptible to cancellations in wet weather. Suitable only as a 'dry weather pitch.'
3	Pipe drained with mole drains	2 - 4	42,500 (Drainage + mole drains) up to 72,500 (Drainage + mole drains + regrading)	6,000 – 11,000	Aeration when conditions allow. Sand dressing not essential, but beneficial. Re-moling every 3 - 5 years.	Low capital and ongoing maintenance cost. In dry weather, surface cracks can render pitches unplayable
4	Pipe drained with sand grooves	3 - 6	72,500 (Drainage + sand grooves) up to 102,500 (Drainage + sand grooves + regrading)	7,500 – 12,500	Aeration and regular sand top dressing (approx 60 - 80 tonnes per annum). Higher drainage rates mean that some irrigation may be necessary during dry periods.	Cost-effective way of improving drainage thereby allowing increased use without damage to the playing surface. Can be used to reinstate slit systems capped with topsoil. Lower cost and less susceptible to soil shrinkage problems. Bands may be capped with topsoil more easily. Depth of bands limited and may not connect with drain trench backfill.
5	Pipe drained with slit drains	3 - 6	70,000 (Drainage + slit drains) up to 100,000 (Drainage + slit drains + regrading)	7,500 – 12,500	Aeration and regular sand top dressing (approx 60 - 80 tonnes per annum). Higher drainage rates mean that some irrigation may be necessary during dry periods.	Cost-effective way of improving drainage thereby allowing increased use without damage to the playing surface. Slits can be capped and sealed with topsoil significantly reducing drainage rates. Surface may be uneven in the first season. Slits may open up during the summer due to soil shrinkage.
6¹⁴	Pipe drained with top soil and drainage layer	3 - 6	145,000 (Drainage + reuse of topsoil from site) up to 240,000 (Drainage + importation of topsoil)	5,000 – 10,500	Some increase in maintenance required. Aeration and sand dressing essential. Increased requirement for irrigation.	Increased drainage rates and wear tolerance. Can be constructed over poor subsoil material. With proper maintenance a hard wearing surface can be achieved. Higher level maintenance required. Pop-up irrigation may be required.
7	Pipe drained with suspended water table	4 - 6	380,000 – 510,000	10,500 – 20,000	Higher levels of fertilizer and irrigation to maintain hard-wearing turf. Top dressing with rootzone-compliant material. Surface aeration work. Artificial upper rootzone reinforcement can be installed for greater durability.	Increased wear tolerance and the performance of play. Very high drainage rates achievable. With proper maintenance a very high standard of playing surface can result. Regular high level of maintenance required. Pop-up irrigation system essential.

¹¹ These figures are a general guide. The playability of pitches depends upon a combination of prevailing weather conditions, physical characteristics of the soil profile and the standard of management provided. The usage levels shown will increase by approximately 50% for players 15 years of age and under.

¹² Estimated at 2011 rates including an allowance for professional fees and contingency. They exclude associated external works and site abnormalities which are site specific and subject to site survey.

¹³ Estimated at 2011 rates for situations ranging from where volunteer help is available (e.g. for mowing, fertilizer application, spiking and line marking) to all maintenance operations being contracted out.

¹⁴ Preferred option for school development projects where new buildings are constructed on existing playing fields, and new pitches are constructed where buildings have been demolished.

Cultivation

Cultivation is the physical manipulation of soil using soil engaging implements and is an essential part of seedbed preparation. Cultivation at a deeper level (with a 'subsoiler') may be necessary on sites levelled by major grading in order to alleviate compaction.

It is important that the works are correctly timed and that soils are only worked in appropriate conditions (i.e. in the Spring or Summer when the soil is dry and friable). To achieve the desired tilth it is essential that the appropriate equipment is used.

With stony topsoil, allowance must be made for the removal of stones or other debris using appropriate stone picking/rotary equipment.

The final seedbed must comprise a smooth surface that is uniformly firm but not over-compacted.

An appropriate fertilizer dressing should be applied prior to seeding or turfing.

Grass cover

The cheapest means of establishing grass cover is by seeding. It is essential that seeding is uniform over the working area.

For rugby and football pitches the seed mixture must comprise predominantly, if not entirely, hard-wearing and fine-leaved cultivars (varieties) of perennial ryegrass. Cultivation of the subsoil is particularly important after major regrading.

Where time is limited, pitches can also be established using purpose grown imported turf, although this is a more expensive option. The turf must contain hard wearing grass cultivars suitable for winter games and be predominantly weed-free. The turf must be grown on light sandy topsoil and should not be excessively fibrous. On specialist constructions, a washed turf may be considered. This is where the entire topsoil base has been washed away before laying.



Seeding a well-prepared, smooth and level tilth from a tractor-mounted seedbox

Turfed pitches often require intensive hollow tine aeration in order to assist surface drainage in the early years of establishment.

Upgrading pipe drained pitches

Properly constructed pipe drained pitches can be upgraded by adding further pipe-drains to achieve a more intensive system. These systems can be supplemented further by installing sand grooves or slit drains to improve the surface drainage performance. However, for this approach to be fully effective, a good drainage connection must be achieved between the sand grooves and the drains below.

Sand amelioration

The drainage characteristics and surface playability of topsoil can be improved by adding suitable sand but it should be noted that a high proportion of sand is required to achieve a significant improvement in drainage performance. Where a high standard pitch is required, the quantity of sand should be determined by laboratory analysis to determine the particle size distribution of the soil and sand. In some cases the sand will be mixed with topsoil off-site with the final rootzone material being spread over the prepared base.

For the majority of pitches it is more cost effective to spread a layer of sand on the pitch (typically 25 mm deep) and lightly work this into the surface of the topsoil to improve infiltration and reduce surface damage from wear. This sand layer is particularly effective when combined with secondary slit drainage and sand grooving systems.

Irrigation

Watering facilities are desirable for winter games pitches not only for initial grass establishment but to assist with renovation of the playing surface. Due to high percolation rates, well-drained pitches will require intensive irrigation to combat problems caused by drying out during periods of low rainfall.



Regular maintenance of the playing surface is essential to prevent expansion of wet areas

The minimum requirement for all pitches is for conveniently located hydrant points where a hose or mobile sprinkler can be connected. For free-draining rooting mediums over drainage rafts, an automatic pop-up irrigation system is essential.

The irrigation system must comply with local water company regulations and this will involve the installation of a system incorporating facilities to prevent reverse siphoning into the water main.

Irrigation may also be required to offset potential problems with soil shrinkage on drain lines where the indigenous soil has a high clay content.

Maintenance

The design of an irrigation system will normally require advice from a specialist Irrigation Consultant on issues such as:

- Irrigation demand
- Capacity and location of water storage
- The potential for use of grey water
- The source and cost of water
- Potential for abstracting groundwater (up to 20 cubic metres per day may be abstracted without a licence)
- Potential for abstracting surface water (up to 20 cubic metres per day may be abstracted without a licence)
- Pumps, power supplies, pipe work, hydrants and sprinklers
- Irrigation scheduling.



Specialist equipment such as a verti-drainer can be hired to maintain pitch quality



Alleviation of soil compaction can greatly improve the condition of natural turf facilities

Maintenance is key to the success of all pitches and is an essential requirement to provide pitches that meet relevant PQS over a long period. There are too many examples of well constructed pitches that fail after a short period of time due to inadequate maintenance, and then require further significant investment to make them effective again.

Typically, post-match work will involve replacing divots and may require the application of top dressing material to the most badly damaged areas of turf. Ensure provision of a reasonable quantity of top dressing sand and that adequate storage facilities are available to keep it dry and clean.

To restore the pitch for the following season a number of operations may need to be performed at the end of the playing year. Provision should be made for aeration, cultivation, sanding, seeding and/or re-turfing.

The following equipment is fundamental to successful maintenance:

- Mower: various models fulfill different requirements. Cylinder mowers produce a better quality finish.
- Aerator: tractor-mounted or pedestrian. This can be hired when appropriate.
- Sprayer: for application of liquid fertilizer and pesticides.
- Chain harrow/roller: to break up clumps and re-level the surface. Heavy rolling should be avoided due to adverse effects on the soil or rootzone.

- Hand tools should include spade, fork, halfmoon turf edger, dragbrush, edging shears, wheelbarrow, measuring and line marking equipment.
- Health and Safety: appropriate Personal Protective Equipment (PPE) should be used.

There is a wide range of equipment available that can be used for aeration or for renovating the pitch surface when a more thorough operation is necessary to restore good surface drainage or to remove excessive fibre or thatch.

This expensive equipment can be hired in as and when required but care is needed to ensure that the work is carried out in suitable conditions.

It is essential to bear in mind that the maintenance requirements for a newly established facility may be considerably higher than for mature playing surfaces.



At the end of the season, over seeding reinstates worn turf

Natural Turf for Sport

Design Guidance Note

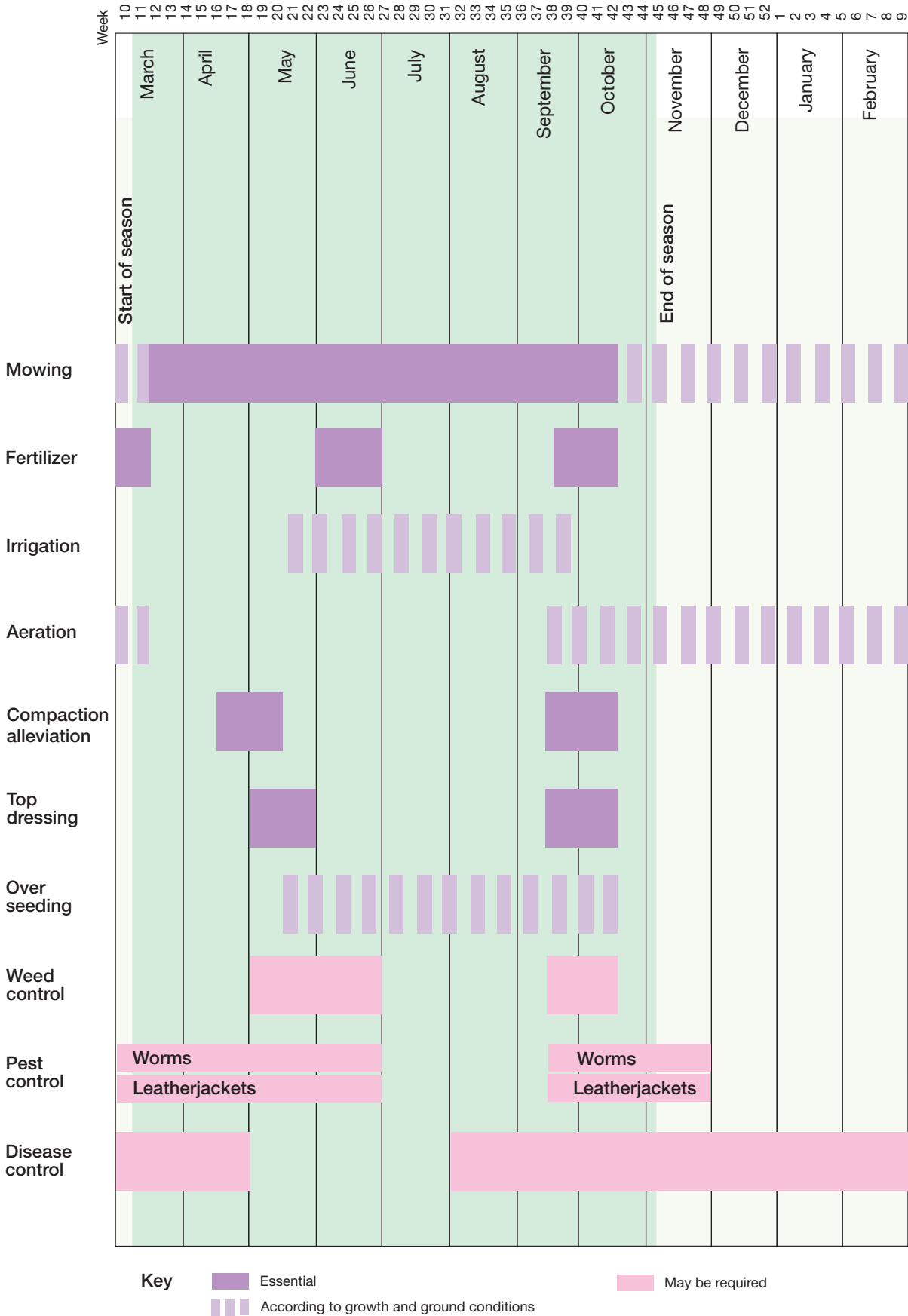

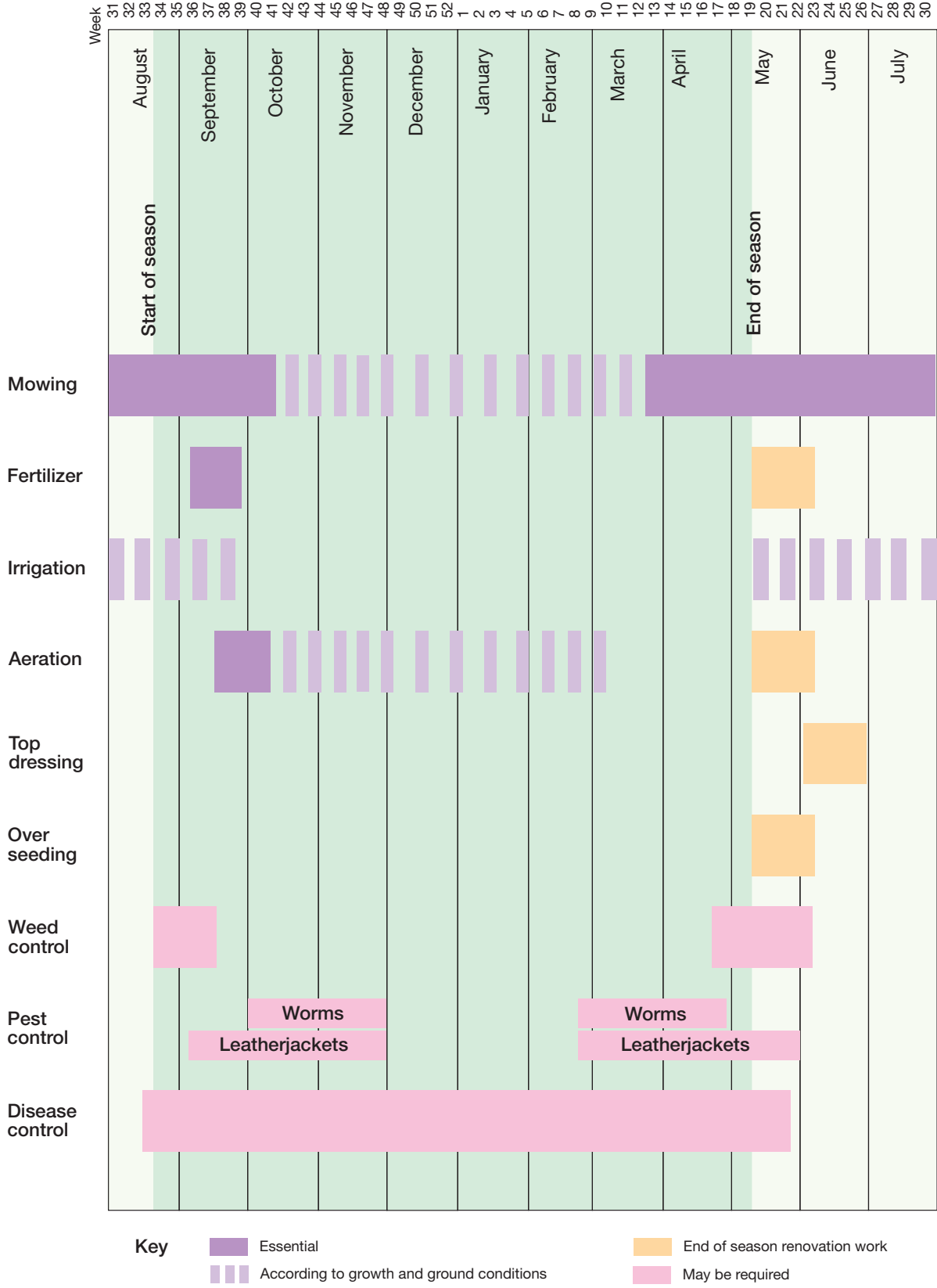

Winter Football and Rugby League: Summary pitch maintenance programme

5.0 Flat And Crown Bowling Greens

Site considerations

Consider the following points when selecting the location for a new bowling green:

- There must be sufficient land available to accommodate the required dimensions of the green and its immediate surrounds.
- Allowance should be made for a surround path, usually 1.5 – 2.0 m wide, and outer planting borders/grass verges as required.
- A detailed survey drawing of the site will be required to establish finished levels relating to the surrounds and to establish the relationship of the pipe-drainage system. Ideally, to avoid subsequent settlement problems, bowling greens should not be built on 'filled' areas.
- The green must be located away from tall buildings and trees that may cast shadows over the bowling surface thereby affecting turf performance.
- Avoid tall plantings around the bowling green.
- There must be good access to the site to facilitate construction work and subsequent maintenance operations.

The basic construction of flat and crown greens is similar – both require the formation of a smooth and uniform bowling surface.

The following sections cover the main stages of construction and the requirements for both types of green.



The green must be located away from tall buildings and trees that may cast shadows over the bowling surface



Plan a perimeter hedge and seating around the green

Grading

Flat greens

A completely level and smooth subsoil formation surface must be prepared with a tolerance of ± 15 mm. Allowance must be made for the various layers of materials used in construction and for making the surface of the green a minimum of 230 mm lower than the surrounds.

Crown greens

Adjustment to subsoil levels must allow for a crown formation between 254 and 380 mm above the corner levels. A 380 mm crown is the Crown Green Bowling Association's recommended height for a 37 x 37 m green and pro rata for other sizes.

Drainage

Greens constructed over porous subsoils such as gravel or sand may not need any special drainage measures but this is exceptional. Most sites will require a drainage raft and an underlying system of pipe-drains.

Flat and crown greens require a perimeter drain beneath the outer ditch channel.

Flat greens

A system of pipe drains should be installed through the graded subsoil formation surface usually at 5.0 - 8.0 m centres with an outlet to an outfall or soakaway.

Crown greens

A drainage system may be omitted from the body of the green as the contouring of the formation allows speedy surface and subsurface water run-off.

All drains must be laid to an appropriate fall with pipework conforming to the relevant industry standard. All junctions, end stops and fittings must be provided as required.

All drain trenches must be backfilled to the formation surface with a layer of hard, clean gravel (6 – 10 mm gravel size).

A suitable silt chamber should be provided at the lowest point of the drainage system on the green surround. A sealed outlet pipe will be required from the silt pit to a positive outfall such as a watercourse, surface water drain or possibly a soakaway.

Once the pipe drains have been installed, a 100 – 150 mm deep drainage layer of 6 – 10 mm hard gravel is spread over the graded formation surface. The layer is then blinded with a coarse, gritty sand to a firm depth of 50 mm.



All sports require a quality-playing surface. Detailed consideration of design, construction and maintenance is essential

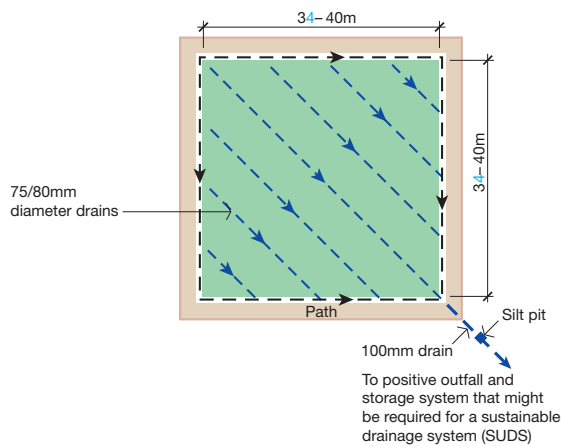

Flat bowling green drainage system

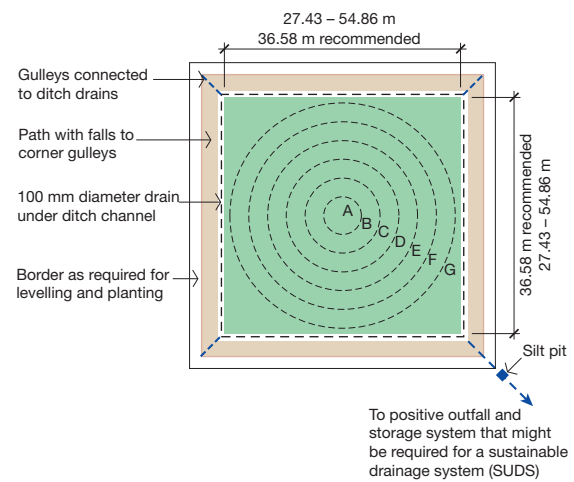

Crown green showing contours and ditch drain

	Circle radii (m)	Circle heights (m)
A	-	0.254
B	3.05	0.248
C	6.10	0.235
D	9.14	0.216
E	12.19	0.190
F	15.24	0.165
G	18.29	0.127

Details of camber formation

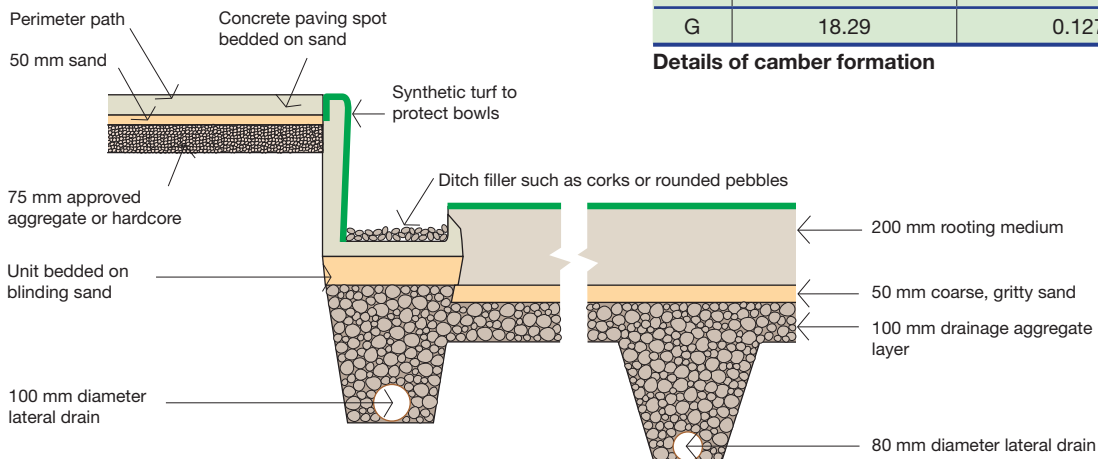

Cross-section through flat bowling green

Ditch channels

Flat greens

The dimensions of the outer ditch channel must conform to the statutory criteria laid down by Bowls England. The height of the outer path surround above the bowling surface is critical.

Traditionally, treated timber boards and / or precast concrete kerb edgings, haunched on concrete, were used to form the ditch channels. More up-to-date systems for ditch channels are now available in the form of pre-cast units manufactured to conform to Bowls England criteria.

In most cases some form of protection is required to protect the bowls when striking the outer ditch face. This can be in the form of treated wooden battens, artificial turf or rubber 'bumper' bars.

Some form of ditch filler such as corks, rounded pebbles or other suitable inert durable material that will not harm the bowls will also be required.

Crown greens

For crown greens where ditch requirements are rather less rigid, traditional timber edging or pre-cast concrete kerbs are usually used. Additionally, crown greens require treated timber striking boards along the outer ditch kerb. Alternatively, synthetic turf may be used.



Pre-formed ditch channel simplifies construction

Rootzone

A free-draining rootzone is required for both crown and flat greens, particularly where rainfall levels are high.

Sufficient rootzone material should be prepared to provide a minimum of 200 mm firmed depth over the blinded drainage layer on completion.

Depending on the location of the green, it may be possible to utilise indigenous topsoil if it is a light textured (i.e. sandy) material. Some preliminary screening of the topsoil to remove larger stones and other debris may be required prior to spreading.

In some situations the drainage qualities of the topsoil might be improved by blending in approved sand. Quantities should be determined by laboratory analysis, and mixing should be done

off-site in dry conditions using appropriate shredders/screeners to ensure the production of uniformly blended rootzone.

If local topsoil is unsuitable, provision must be made to import suitable commercially prepared sand/soil rootzone material. The approved rootzone must be spread using appropriate equipment taking care not to disturb the underlying blinded drainage layer.

Seed / turfbed preparation comprises alternating hand-raking and heeling operations in order to produce a fine, smooth and evenly consolidated tilth.

Preparation

Note that for all greens it is imperative that topographical information is available to aid the design and setting out.

Flat greens

Levelling pegs must be set up on a 3 m grid or alternatively 'screeding battens' can be used to accurately set out the levels. Final levels must be to a tolerance of ± 6 mm.

Crown greens

It is important to maintain correct contours and levels by setting up level pegs at 3 m centres on each contour line.

Seed bed / turf bed preparation

In the final stages of seedbed / turfbed preparation a suitable fertilizer dressing should be well raked into the surface.

Grass cover

Grass cover can be established by seeding or turfing, depending on the budget and the time available before the facility is required for use.

Seeding is the cheaper option but a longer establishment period is required, usually a minimum of 18 months. The seed mixture should contain approved cultivars of fescue and bents. A sowing rate of 35g / m² is normally used.

Turfing is more expensive, but requires a shorter period to become established (usually between six



Where time is limited, grass can be established by turfing although this is more expensive

and nine months). Turf must be purpose grown on a light sandy topsoil using fescue and bent grasses and should be free of broad-leaved weeds and weed grasses.

Traditionally turf is supplied in narrow rolls (approximately 300 mm wide) and laid by hand working from boards. Wider rolls, up to 1.2 m across, are now available. These can be laid directly from specially made tracked machines.

Irrigation

During construction works, a suitable irrigation system must be installed. This is necessary to assist establishment of the grass sward and to aid future maintenance of the green.

A basic system comprises one or two water hydrants located around the outer edge of the green. Given adequate pressures and flow rates, these can be used for supplying portable sprinklers, spray lines or self travelling sprinklers.

A more expensive option involves the installation of an automatic pop-up irrigation system. This comprises between four and eight sprinkler heads located outside the bowling green perimeter.

This system also includes a storage tank, pumps and control. All will require safe and secure housing near the bowling green.

The irrigation system must comply with local water company regulations and this will involve the installation of a system incorporating facilities to prevent reverse siphoning into the water main.

Green surrounds

Some form of path will be required on the outside of the green for pedestrian access and/or spectator viewing. The following must be considered:

- The perimeter path must be formed from a durable, level material such as brick / slab paving or macadam.
- Provide safe, easy access to the green for wheelchair players.
- Outer borders may be required for the planting of ornamentals, shrubs and/or perimeter hedging.
- Tree planting demands a cautious approach owing to the potential for harmful shading of the green, as well as penetrating root systems.
- A well-detailed type of outer perimeter boarded fence must be provided for shelter and security.
- Make allowance for sufficiently wide access gates through the fence for maintenance machinery.

- Facilities such as seat recesses, litter bins, path drainage gulleys and access ramps to the green must also be provided.

Maintenance

Maintenance requirements will depend upon site conditions and prevailing growth. Proper management will be vital to the achievement of the best possible playing surface and top dressing the green will be crucial in achieving this.

Other maintenance requirements should be discussed and agreed with the green design specialist who should provide a detailed maintenance schedule with the original design.



Regular maintenance is essential to ensure a high quality playing surface is achieved

Consideration of these requirements must not be left until the works are completed.

The following equipment is fundamental to successful maintenance:

- Mower: a high quality professional cylinder mower, the most expensive and important piece of maintenance machinery.
- Aeration machine: ideally a powered, pedestrian version.
- Scarifier: the most efficient are powered, pedestrian models.
- Sprayer: for pest and disease control.
- Spinner-type pedestrian distributor: to achieve even application of granular materials, especially fertilizers.
- Irrigation: portable sprinklers or spray line to water the green. Hydrant points should be fitted with reverse siphon valves.
- Hand tools: including a switch, dragmat or dragbrush, edging shears, fork, spade and springbok rake. A large lute will be required for flat greens.

Expensive equipment that will rarely be used such as a punch-action hollow tine machine or top dresser, should be hired in as and when required.

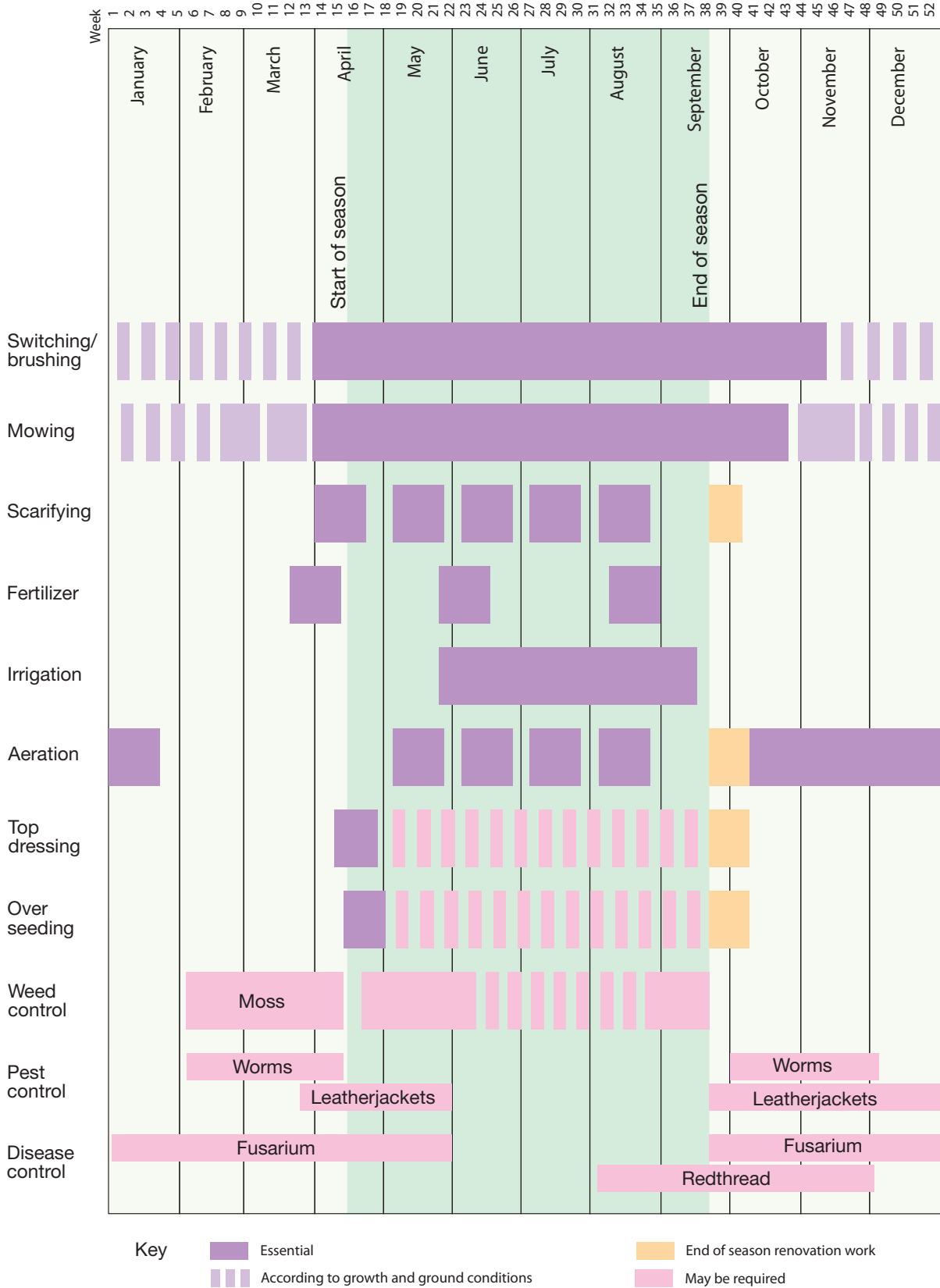

6.0 Cricket Grounds

The following guidance will assist clubs and schools during the early stages of planning a new cricket square or pitch. The guidance does not, however, go into great detail in terms of design, construction and maintenance issues and therefore, these must be considered in relation to the guidelines available from the England and Wales Cricket Board (ECB). In particular, the ECB publish their own guidance on the construction, preparation and maintenance for the relevant standard of play¹⁶. Additionally, for all but the smallest projects, expert independent advice must be sought.

ECB publish their own PQS for cricket and these are very important in the design, construction and maintenance of cricket facilities and must be achieved for the relevant standard of play.

Initial planning

Firstly, identify the level of cricket to be played and the associated PQS required.

Plan the square to have a lifespan of 25 years and factor in realistic maintenance costs to achieve this.

The boundary should be a minimum of 37.00 m (for 'juniors') and 45.72 m (for 'seniors') from the middle stumps of the pitch in current use.

Pitches must run approximately north / south to minimise the risk of batsmen or bowlers facing a low sun. The pitch axis must point in a direction between 325 and 55 degrees on the compass.

For seniors, a single pitch area is 20.12 m long x 3.05 m wide. For juniors, the pitch length is reduced to 19.20 m (U13), 18.29 m (U11) and 16.46 m (U9) respectively. The size of the cricket square is determined by the number of pitch areas required in a season.



Precise placement and consolidation of cricket loam is crucial to the success of cricket square construction

To calculate this:

- Assess the total number of matches to be played during the season.
- Assess the number of times each strip can be used during the playing season. This is variable but could be between two and five times dependent on the type of cricket, the standard of maintenance and the time available to the groundsman to maintain and prepare the pitches.
- Calculate the number of pitches required and hence the total width of the square: the number of matches to be played divided by the assessed number of games per pitch gives the total number of pitches required.

Site investigation

Before making decisions about the construction of the cricket ground it is important to identify the characteristics of the indigenous soil. This is achieved by analysis of the topsoil and the subsoil from a minimum of six locations on the site. The soil analysis should be conducted by an experienced consultant using an approved, independent soil laboratory.

The initial investigation should identify the site's natural run-off and the location of existing drainage. Where available, obtain copies of drainage plans.

Ensure there will be reasonable access for construction vehicles and take steps to protect the outfield from damage by heavily laden traffic.

Following initial planning and site investigation and before proceeding further, the following information must be available:

- Required size of square
- Depth of dig for construction of the square
- Drainage requirements for the proposed square and outfield including any anticipated future expansion.

¹⁶ See ECB website at www.ecb.co.uk.

Falls

The final surface level of the square must be of a consistent and uniform grade and blend in with the outfield. However, it should be 25 mm higher to encourage surface water to run off.

Ideally, the square must be completely level along the line of play, although a slight fall of up to 1:100 might be acceptable.

A slight cross-fall of between 1:80 and 1:100 is also acceptable to assist surface run-off.

Materials

Cricket demands a firm, level surface that provides consistent bounce and pace. The selected soil will have a major influence on the physical characteristics of the playing surface and will also affect the selection of grass cover.

The nature of the existing topsoil will determine the extent of the construction works required to develop the square. For different standards of pitch, the clay content should be:

- First class and county 28 – 35 %
- Club 25 – 30 %
- School 23 – 28 %.

Note that marl should not be used.

The clay content of the topsoil will be indicated by a soil analysis carried out at the initial planning stage. Where existing topsoil is unsuitable, make allowance for importing an appropriate cricket topsoil from a specialist supplier.

To accommodate the imported topsoil, an equivalent depth of existing material must be removed. The imported topsoil must be blended with the indigenous topsoil.

For cricket squares refer to specialist advice from the England & Wales Cricket Board (ECB).

See their document entitled 'TS4 - Recommended Guidelines for the construction, preparation and maintenance of cricket pitches and outfields at all levels of the game'.

Drainage

The drainage system must be designed by a specialist to meet the demands of the location and planned pitch use.

In its simplest form the drainage system will comprise a single perimeter drain around the outer edge of the square.

Except when designed with a drainage raft, never install a pipe-drainage system under the square as this will result in differential drying out at the surface. Drains should not be laid with falls less than 1:200.

'Drainage rafts' are required only in exceptional circumstances, such as in situations where shallow ground water results in very wet sites or where the highest standards of construction are required, for example, at county level.

Construction

Excavate topsoil to required depth, invariably 100 – 150 mm. Install the drainage system. If excavation exceeds 100 mm introduce appropriate loam in layers no deeper than 50 mm.

Soil should be consolidated every 50 mm by heeling. While time-consuming, consolidation is the most important element of the construction process and must be carefully supervised.

Alternative methods of consolidation are available, for example with 'wacker plates' but this should be discouraged. All levels must be keyed in and air pockets removed. Failure to carry out this process diligently will curtail the expected lifespan of the pitch or square and lead to disruption and additional costs.

Levelling and construction can be achieved with levelling pegs or laser levelling equipment and, if correctly carried out, there should be no need for overlapping. The success of this procedure relies on exact marrying up with the outfield.

A roller must not be used for the final levelling as this may leave isolated pockets that can only be eradicated by 'walking and heeling'.

Seeding

Note that turfing a pitch or square is strongly discouraged. Grass cover is normally established by seeding using appropriate cultivars of suitable grass species sown at a rate of 35 g/m². The selection of a suitable seed mixture will depend on proposed intensity of use and levels of management and maintenance available.

The seed mixture should be selected in consultation with a specialist and take account of advice available from the ECB. Successful seedbed preparation relies on the following steps:

- Ensure all stones are removed
- Rake the surface and, where necessary, apply a pre-seeding fertilizer
- Spread the seed uniformly then lightly rake into the surface and roll with a hand-roller
- Water the seedbed
- Provide protective fencing around the perimeter to prevent encroachment onto the new surface.

The square will be ready for use between 18 months and 2 years after seeding.

Irrigation

Provide at least one hydrant point at a location convenient to the square such that it is possible to water each of the pitches. A hose or sprinkler can be attached for general watering of the square and / or preparation of pitches. The irrigation system must comply with local water company regulations and this will include the installation of a system incorporating facilities to prevent reverse siphoning into the water main.

Automatic pop-up irrigation systems are not usually installed on cricket grounds.

Outfield

The outfield must comprise smooth and even levels that permit balls to roll freely across the

surface. If the outfield is to be cut from grassland the site must be checked for:

- Uneven surfaces
- Inadequate drainage
- Inappropriate grasses.

Where the quality of turf is satisfactory and site undulations are isolated, it should be sufficient to strip away portions of turf and, where necessary, adjust the underlying ground level.

The turf is then replaced to form a level and firm surface.

Where site undulations are more severe but there is a good depth of topsoil, it may be enough simply to regrade the site to a uniform surface.

Where existing gradients are too steep, more drastic level adjustment may be necessary involving the removal of topsoil and grading of exposed subsoil, followed by topsoil replacement.

The outfield need not be completely level and a slight gradient of up to 1:50 may assist shedding of surface water.

Outfield drainage

Where rainfall levels are low and topsoil is naturally free-draining there should be no need for artificial drainage, particularly if the outfield is to be used for summer cricket only.

If the ground is relatively impervious some form of pipe drain system may be required.

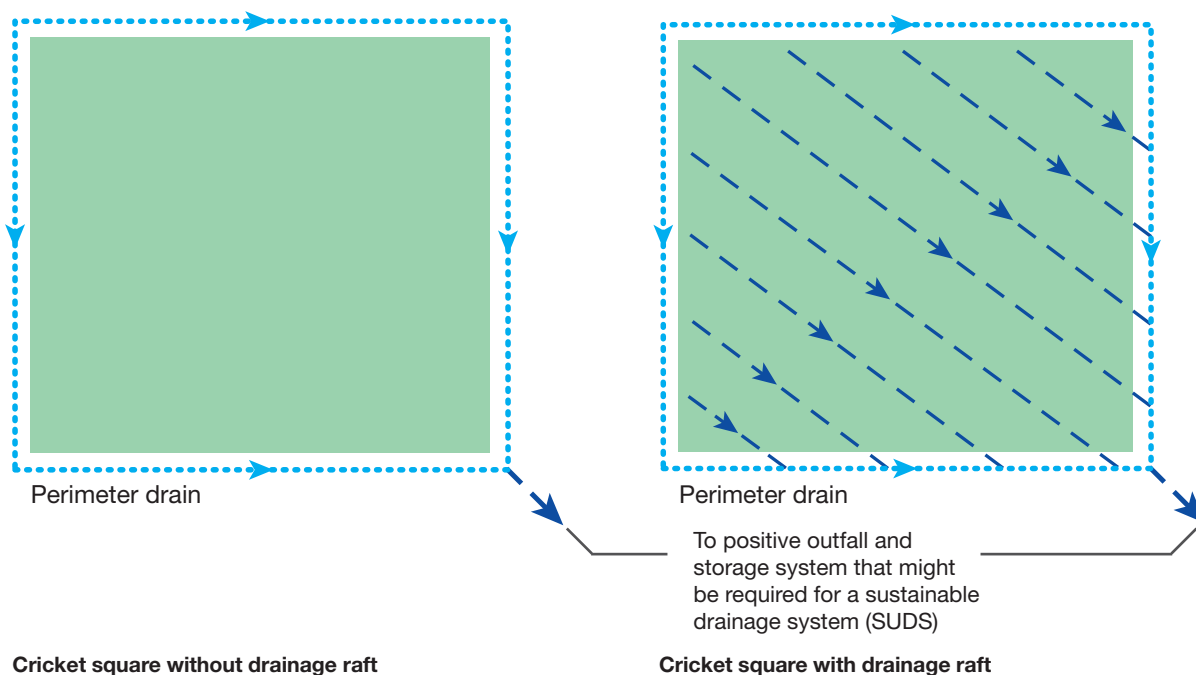

Cricket square without drainage raft

Cricket square with drainage raft

Where the outfield will be used as a playing surface for football, rugby or hockey, construction should follow recommendations for those sports. While supplementary slit drains may be used on cricket outfields caution is advised owing to the possibility of settlement of backfilling material within the slits during dry weather. This will result in an uneven playing surface which is potentially dangerous for fielders. Make allowance for topping up the slits with suitable sand when settlement occurs.

Grass cover

For the finest quality outfields, mixtures containing appropriate species of fescue and bent are most appropriate.

Where winter games are to be played on the outfield, the inclusion of a proportion of perennial ryegrass is essential to maintain the hard wearing quality of the surface in anticipated wet winter playing conditions. The cultivars chosen should have a high tolerance to close mowing. A seed mixture containing between 40 – 60% by weight perennial ryegrass would be suitable for most winter games situations.

Maintenance

Detailed guidance on the maintenance of cricket squares and outfields is available from the ECB.

Requirements will depend on:

- Site conditions
- Prevailing growth
- Intensity of use.

Equipment

The ECB provides detailed guidance on the equipment necessary to maintain the quality of the playing surface throughout its life. It is vital that this guidance is considered in detail during consultation with your appointed specialist from the outset of the project. In particular, provision will need to be made to house specialist equipment such as a roller.

Non-turf pitches

Non-turf pitches are popular for practice and occasionally for matches. The ECB has set performance standards for these pitches which are implemented through suppliers approved and regulated by the Board.

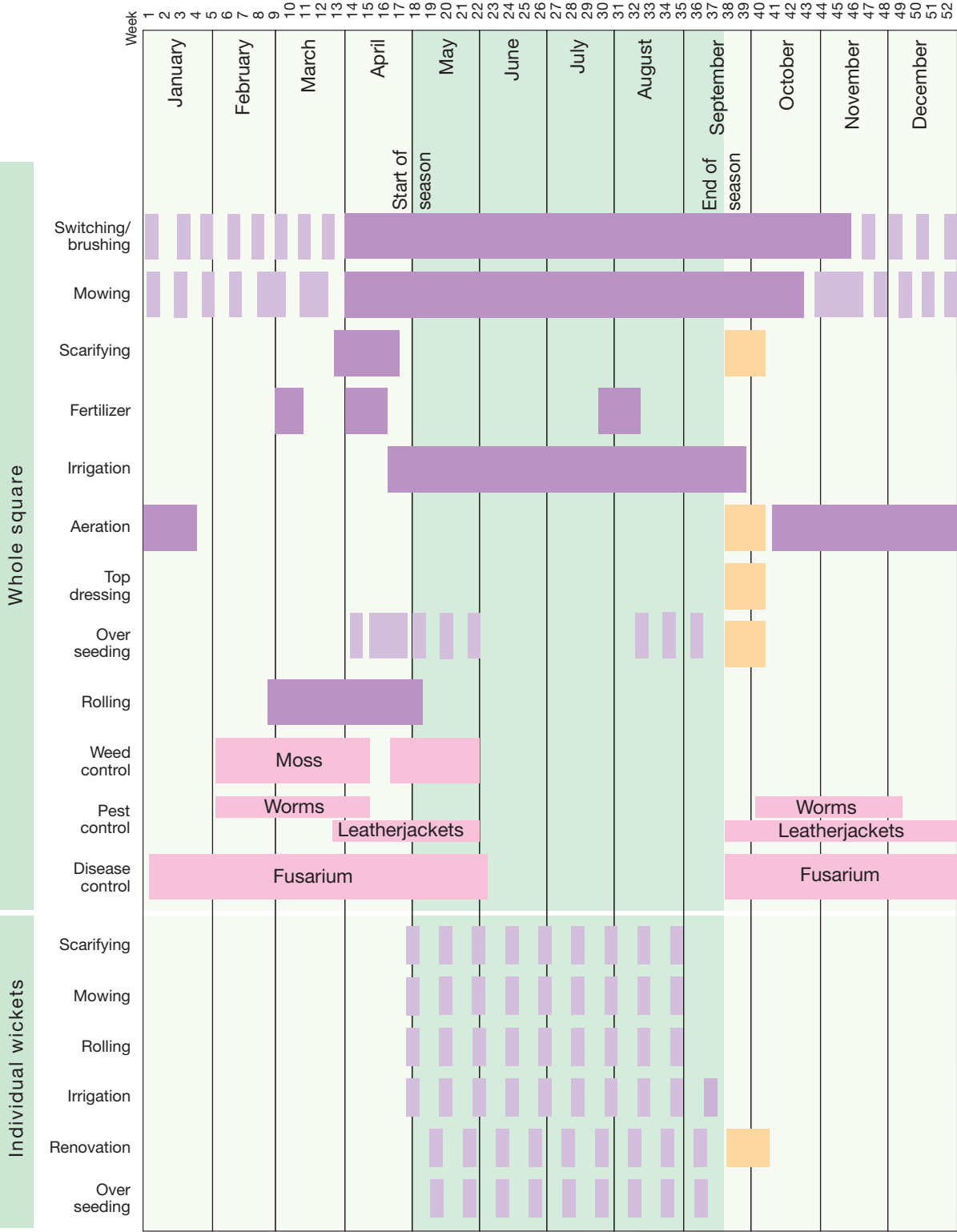

Key Essential End of season renovation work
 According to growth and ground conditions May be required

A summary maintenance programme for cricket squares

APPENDIX 1

Selection criteria for consultants on turf / grass projects

The selection of the right consultant for sports turf and sports drainage work is as critical as getting the right architect to design the clubhouse or sports hall. Choosing the right consultant will save time and money and will bring real added value to the design, construction and maintenance of the pitch over many years.

The following are critical issues that need to be considered when selecting a suitable consultant:

- Does the consultant have relevant qualifications and expertise such as:
 - currently recognised as acting as an independent consultant in the sport turf/ grass industry?
 - a recognised plant or earth science degree?
 - references from at least two clients for similar work?
 - sufficient expertise to cover all of the work required for example drainage as well as pitch works?
- Ensure that the consultant:
 - is independent and does not have any formal association or understanding with any commercial organisation that could influence his or her impartiality.
 - holds an appropriate level of professional indemnity insurance.
 - demonstrates a clear understanding of the brief and your requirements.
 - has the ability and the resources required to meet the necessary deadlines.
 - confirms the total cost of the professional services and if there are likely to be any additional costs.
 - demonstrates a willingness to attend for an interview and/ or present their submission.
 - provides ongoing support following the completion of the main works.

APPENDIX 2

Schedule of services for a sports turf consultant employed on playing field and natural turf pitch improvement schemes

The construction of safe and sustainable natural turf surfaces that meet appropriate PQS is reliant upon competent execution of site assessment, design, construction and maintenance phases. It is therefore advisable to appoint a specialist sports turf consultant to coordinate the project.

A fee proposal from prospective consultants should include details of:

- The Company
- Staff to be assigned to the project and their respective qualifications and experience
- The proposed working and liaison arrangements
- Any sub-consultants proposed (e.g. irrigation consultants)
- A fee bid including key deliverables.

The following is a summary of the Schedule of Services to be provided by a specialist consultant employed on a playing field or natural turf improvement scheme, separated into the following key project phases:

- Feasibility study
- Design
- Tender
- Contract administration.

Feasibility Study

The feasibility phase of the project may include the following:

- In consultation with the Client, identify the appropriate PQS for the site with reference to the range and level of the sports to be played.
- Undertake a topographic (levels) survey of the site to establish gradients and surface level uniformity to assist with the design of earthworks and drainage.
- (Optional) undertake a geophysical survey (e.g. Electro-Magnetic Inductance Scans) to assist in establishing soil variability beneath the site and to target detailed investigations.
- Determine hydrological characteristics for the catchment including the standard-period

average annual rainfall (to inform future drainage design), proximity to watercourses, potential for runoff and whether the site lies within an indicative flood plain or groundwater source protection zone. This information can be used to establish whether there is scope to undertake site remodelling works without affecting the volume or dynamics of a flood plain, and whether the construction of a deep-bored soakaway for the discharge of surface water is likely to be permitted should a more convenient method of outfall not be available.

- Determine the likely underlying geology from geological maps and/or soil survey records.
- Identify site factors that may require further surveys or investigative work (e.g. site history, previous use, tree protection, ecology, archaeology, conservation Site of Special Scientific Interest (SSSI), utility services, contaminated land and land drainage consent).
- Conduct a physical site survey to confirm the following:
 - Site location and access including any restrictions to construction traffic and contact details for site access arrangements.
 - Current land use.
 - Existing site layout including the orientation and dimensions of pitches to ascertain whether they comply with Sport England recommendations.
 - Excavation of test pits to characterise the underlying soil profile in terms of soil type, nutrient status, salinity, organic matter content, compactive state, rooting depth, depth to shallow rock and drainage status (including depth to groundwater if encountered). This should also include additional pertinent information such as stone content, suitability of the underlying material for site remodelling and the presence of material that could potentially be contaminated.
 - Determine whether there is evidence of the presence of existing drainage infrastructure and, if so, scope for utilising this within the proposed remediation works.
 - Conduct an agronomic and PQS assessment to include grass height, ground cover, presence of weeds, thatch depth, rate of water infiltration through the surface, surface evenness, site gradient, hardness and pH.

- Assess irrigation requirements (if any).
- Assess floodlighting requirements (if any).
- Establish the current and proposed level of site usage.
- Establish whether planning consent is required or whether certain planning conditions need to be discharged.
- Establish whether a Flood Risk Assessment is required.
- Summarise of the principal factors affecting the condition of the natural turf sports facility.
- Propose development options and cost.
- Propose an appropriate maintenance programme with budget costs.
- Provide an indicative work programme for the possible phasing and duration of the proposed construction works. This should also indicate when the sports facilities may be available for use.
- Summarise implications of the proposed works on future maintenance, longevity and usage.

Design

Production of detailed designs, specifications, construction drawings and bills of quantities to address the development issues identified in the feasibility study. This will ensure that the appropriate PQS can be achieved. The documentation should include the following information¹⁷:

- Introduction and site information.
- Site location and access.
- A summary of findings from the feasibility study.
- General scope.
- Detailed specification.
- Drawings showing details such as proposed layout, existing and proposed levels, drainage layout, cross-sections, schedule of inspection chambers including invert levels and Isopachytes.
- Indicative work programme.
- General notes.

- Confirmation or otherwise as to whether the project is notifiable under the Construction (Design and Management) Regulations 2007 and inform the Client of their responsibilities under these regulations.
- Assist in the appointment of a CDM Coordinator (if appropriate).
- Designer's assessment of residual risk.

Tender

- Recommend the Form of Contract to adopt.
- Produce tender documentation which, assuming a traditional procurement route is selected, may include:
 - Instructions for tendering
 - Preliminaries
 - Conditions of Contract
 - Site information
 - Description of the works
 - Scope of works
 - Constraints of how the contractor provides the works
 - Contractor's design elements
 - Programme
 - Specifications
 - Bill of quantities / Work Schedules
 - Design drawings
 - Requirements for Construction (Design and Management) Regulations 2007
 - Underground and overhead services
 - Form of Tender
 - The Agreement.
- Despatch tender packs.
- Attend mid and post tender interview as appropriate.
- Produce a tender analysis report with recommendations for the appointment of a suitably qualified contractor.

¹⁷ See Model Contract Specifications that are downloadable from the Sport England website.

Contract Administration

Manage the construction phase to ensure that the requisite PQS are achieved. This should include the following:

- Chair a pre-contract meeting to address any issues raised prior to presiding over the signing of a contract agreement.
- Produce a Project Directory.
- Organise, chair and administer regular site meetings/visits including the provision of agendas and minutes, and observe key operations to confirm compliance with the specification. These may include, but are not limited to, inspections and testing of:
 - Site remodelling / re-grading
 - Topsoil placement
 - Drainage installation
 - Materials testing (soil, sand, rootzone and gravel)
 - Seedbed preparation
 - Grass establishment.
- Initiate and maintain a Site Visit Log to keep a record of site activities as the project progresses. Information may include:
 - Project name
 - Client, Contractor, Contract Administrator and CDM Coordinator
 - Project start date
 - Date of visits
 - Plant on site
 - Weather conditions
 - Ground conditions
 - Comments and observations on progress
 - A summary of recommendations agreed during the site visit
 - Details of materials conformance testing.
- Prepare financial statements and cash flow forecasts as required.
- Assess valuations provided by the contractor and produce interim and final valuation certificates.
- Produce sectional and practical completion certificates.
- Prepare snagging list.
- Monitor the site during the defects liability period.
- Assess the site against the requisite PQS prior to project sign off.
- Project sign off.

APPENDIX 3

Key Project Stages				
	RIBA Work Stage	People involved	Key Actions	Key Outputs
PREPARATION	Stage A Appraisal / Briefing	Client Stakeholders	Identification of Client's requirements and any possible constraints on development, including funding. Preparation of studies to enable the Client to decide whether to proceed.	Inauguration of project steering group. Compilation of relevant information including: <ul style="list-style-type: none"> • A site plan showing extent of land, ownership, legal agreements, covenants, way-leaves, rights of way, existing buildings, mains services, pitch layouts, local knowledge of ground conditions and any other site factors. • Maintenance arrangements, detailing who will be responsible for pitch maintenance, and the annual budget required. • Layout details of existing and proposed pitches and associated sports. • Existing and proposed programme of use including age and sex of players. • Changing room provision. • Car park requirements. • Access arrangements for spectators/players with disabilities. • Expected level of user performance (e.g. local league or county standard) and relevant Performance Quality Standards (PQS). • Project programme including anticipated commencement and completion of works, and when the pitch(es) will be ready for play. • Arrangements for using alternative facilities during the construction phase. • The outcome of initial consultation with the Local Planning Authority to gauge likelihood of obtaining planning permission. • The outcome of initial consultation with The Environment Agency or other statutory body to gauge likelihood of discharging pitch drainage into a watercourse or existing piped infrastructure. • Possible funding sources.
	Stage B Business justification	Project Steering Group	Confirmation of key requirements. Identification of potential Pitch Consultants. Assessment of project viability.	Obtain competitive quotations from competent consultants (see Appendix 1) to carry out the required consultancy services (see Appendix 2): <ul style="list-style-type: none"> • A baseline PQS assessment. • A detailed site investigation in order to characterise the underlying soil profile. • Determination of a range of appropriate development options for the pitch(es) in consultation with the Client. • Derivation of indicative remediation/construction costs for budgetary purposes and costed options where applicable including recommended maintenance operations. • An indicative work programme in order that the Client has a clear picture of the duration of the proposed construction works and when the pitch(es) may be available for use. The following is optional, but desirable: <ul style="list-style-type: none"> • A detailed topographical (levels) survey of the site to establish gradients and surface level uniformity to assist with the design of earthworks and drainage. • A geophysical survey (Electro-Magnetic Inductance Scan) to assist in establishing soil variability beneath the site and to target detailed investigations. Assessment of project viability based on findings from the feasibility study.

Key Project Stages				
	RIBA Work Stage	People involved	Key Actions	Key Outputs
DESIGN	Stages C, D & E Outline proposals Scheme design and planning Detailed design	Project Steering Group Pitch Consultant	Establishment of procurement strategy and form of contract to be entered into between the parties. Preparation of designs or Employer's Requirements – as appropriate. Application for full development control approval.	For traditional contract: <ul style="list-style-type: none"> • Production of detailed designs, specifications, construction drawings and bills of quantities for addressing the development issues identified in the feasibility study. For design and construct contract: <ul style="list-style-type: none"> • Production of Employer's Requirements document to include information on: <ul style="list-style-type: none"> ○ Scope of Works (Provision of design development and working drawings, tender and detailed specifications, calculations, method statements, samples and mock ups for testing, testing of materials and assemblies, operating and maintenance manuals, protection of works and a turf maintenance manual). ○ Detailed Scope of Works (Details on requirements such as trimming the formation surface, profile construction materials, land drainage system, under soil heating system, irrigation system, pitch reinforcement system, grass sward establishment (seeding or turfing), initial agronomic maintenance and requirements for goal posts and sockets). ○ Design Principles. ○ Design responsibility (Contractor and Consultant). ○ Statutory Approvals. ○ Drawings (requirements). ○ Tender Submissions (General systems and materials specification, outline methods statement, drawings, outline programme of works, risk assessment, health, safety and welfare). ○ Post Tender Submissions (Detailed specifications, detailed programme of works, samples and analyses of materials, supporting calculations, quality control procedures and detailed method statements). ○ Construction Submissions (Construction materials, operating and maintenance manuals, record information and drawings). ○ Performance Quality Standards. ○ Level and Pattern of Usage. ○ Design Life.
	Stages F, G & H Detailed design information Tender documentation Tender process	Project Steering Group Pitch Consultant Potential Contractors	Final agreement on design, specification, construction and cost. Statutory approvals. Preparation of tender documentation. Identification of potential Contractors. Receipt and appraisal of Tender Bids. Recommendations made to Project Steering Group to allow appointment to be made.	<ul style="list-style-type: none"> • Production of contact documentation. • Preparation of tender packs. • Hold pre-tender briefing for potential Contractors to ensure that they have a good understanding of the project. • Obtain and appraise tenders. • Select Contractor.
PRE-CONSTRUCTION				

Key Project Stages				
	RIBA Work Stage	People involved	Key Actions	Key Outputs
CONSTRUCTION	Stages J & K Project planning Construction through to Practical Completion	Project Steering Group Pitch Consultant Contractors Sub-Contractors	Appointment of Contractor. Site hand over to Contractor. The Consultant administers the contract up to Practical Completion. Site handed back to Client.	<ul style="list-style-type: none"> • Appointment of Contractor. • Site hand over to Contractor for mobilisation. • Production of construction programme by Contractor. • Construction monitoring by Consultant including preparation of interim payment certificates and compilation of the final account. • Regular site inspections to ensure that the specification is adhered to. • Site handed back to Client.
	Stage L Completion On going maintenance	Pitch Consultant Contractors Sub-Contractors Project Steering Group	Defects liability period commences. Final inspections. Project sign-off. Final account is settled. Maintenance budget.	<ul style="list-style-type: none"> • Site inspections by the Consultant during the defects liability period. • Defects made good by the Contractor. • Testing against Performance Quality Standards. • Project sign-off. • Aftercare and ongoing maintenance programme. • Periodic testing against PQS.

APPENDIX 4

Performance Quality Standards

Objective testing to establish the PQS of turf facilities forms an essential part of the development and maintenance of natural turf playing surfaces. These standards should be included in specifications for developing, improving and maintaining natural turf for sports facilities, as appropriate, to provide a consistent measure to confirm compliance with the specification.

Many of these test procedures are described in BS7370 Part 3 and in the STRI test procedures for the assessment of pitch hardness. The PQS information contained within this table constitutes selected key minimum criteria. For more detail, please refer to the relevant IOG publications.

These standards should be regarded as a minimum standard for the provision of pitches for football, rugby and cricket. In some cases, these standards can be refined or supplemented with additional requirements where it is appropriate to the site or the standards required.

For cricket there are more detailed guidelines set out in *'Recommended Guidelines for the construction, preparation and maintenance of cricket pitches and outfield at all levels of the game'*. This is available for download from the ECB website at www.ecb.co.uk.

Element ¹⁸	Limits adopted by Football Association	Limits adopted by Rugby Union Rugby League	Limits adopted by Cricket			Method of Test
			Square	Pitch	Outfield	
Grass height (mm)	30-60 GS 20-70 NGS	25-65 GS 25-75 NGS	8-14 GS 16-25 NGS	6-7 GS	16-25 GS 18-38 NGS	BS 7370 : P3 A3
Ground cover (%)	>75	>70	>80	50-70	>80	BS 7370 : P3 A6
Broad-leaved weeds (%)	<10	<10	Nil	Nil	<3	BS 7370 : P3 A6
Thatch depth (mm)	<15	<15	<2	Nil	<15	BS 7370 : P3 A7
Water infiltration rate	5 (mm/h)	>2 (mm/h)	N/A	N/A	2 (mm/d)	BS 7370 : P3 A8
Evenness - 2 m straight edge (mm)	<25	<25	<10	<10	<20	BS 7370 : P3 A4
pH value	5.8-7.5	5.8-7.5	5.5-7.0	5.5-7.0	5.8-7.5	ISO 10390
Slope ¹⁹						BS 7370 : P3 A5
Direction of play (%)	<1.00 - 1.25	<1.00 - 1.25	<1.11	<1.11	<1.67	
Across play (%)	<1.25 - 2.00	<1.25 - 2.00	1.25 - 1.67	<1.67	<1.67	
Hardness (gravities)	35-200	40-180	N/A	>200	30-200	STRI method of test using a 0.5 kg Clegg Impact Hammer from a drop height of 0.55 m
Key: GS = Growing season NGS = Non-growing season						

¹⁸ The PQS information contained within this table constitutes selected key minimum criteria. For more detail, please refer to the relevant IOG publications.

¹⁹ These values are expressed as a minimum that will avoid the slope having an adverse effect on play, but should be regarded as the preferred values in terms of surface drainage. However in some locations with heavy annual rainfall, these figures may need to be exceeded.

APPENDIX 5

Maintenance resource check list

When considering the viability of developing a new natural turf sports facility, or improving existing facilities, the provision of sufficient maintenance resource is crucial to the success of the project.

The maintenance operations required, and the timings of these activities, will vary depending on the range of sports supported and site specific

factors (e.g. construction type, usage, level of play and weather conditions). See the 'Summary Pitch Maintenance Programmes' in Sections 4.0, 5.0 and 6.0 for specific sports contained within this guidance note.

The following check list is not exhaustive, but is intended to provide stakeholders of a potential natural turf sports development with a list of resources that may be required in order to optimise the quality of the facility and the longevity of the capital investment.

<p>People and skills</p>	<p>When recruiting grounds staff (either voluntary or paid) responsible for the agronomic maintenance of the facility, consider if applicants:</p> <ul style="list-style-type: none"> • Are practical and fit • Have suitable experience, or whether there is a need to attend appropriate Institute of Groundsmanship courses • Have at least 3-4 years experience at 2 or more grounds (for a Head Groundsman) • Lack experience or knowledge, and will require provision for commissioning the services of a Sports Turf Agronomist to carry out routine visits and produce agronomic recommendations.
<p>Premises</p>	<p>Facilities required and available should include:</p> <ul style="list-style-type: none"> • Secure machinery maintenance and storage area • Appropriate storage for consumables (e.g. sand, fertilizer and agro-chemicals) • Fuel storage • Machinery wash down area • Storage area for disposal of grass clippings and composting (away from water courses) • Welfare facilities for staff.
<p>Machinery and tools</p>	<p>Basic maintenance equipment should include:</p> <ul style="list-style-type: none"> • Mower • Fertiliser distributor • Line marking equipment • Selection of hand tools such as strimmer, spade, shovel, devotting fork, brushes, switches, rakes and a wheel barrow • Measuring tapes, ropes, strings, measuring jugs / cylinders, buckets and pegs. <p>Access to the more specialised maintenance equipment, or provision to use specialist contractors, particularly for end of season renovations should include:</p> <ul style="list-style-type: none"> • Scarifier • Topdressing distributor • Overseeding drill • Sprayer • Vertidrainer • Hollow and solid tining equipment • Linear decompactor • Chain harrows • Drag mats • Irrigator.

APPENDIX 6

Playing areas

Ensure that consideration is given to the essential support facilities such as:

- Changing and social facilities
- Access and car parking
- Secure storage for maintenance machinery and sports equipment
- Storage for pesticides.

See the following separate Design Guidance Note downloads available from the Sport England website:

- *'Pavilion and Clubhouses'*
- *'Car Park and Landscape Design'*
- *'Comparative Sizes of Sports Pitches and Courts'*.

***The Football Association
publish their own PQS.***

See Appendix 4.

***See also their publication
'Football Facilities in
Schools' for recommended
goal posts and pitch sizes.***

The following pitch layouts are included:

- Mini soccer
- Youth football
- Senior football
 - with sand grooves
 - with mole drains
 - with slit drains
- Rugby Union
- Rugby League
- Softball
- Baseball
- Cricket
 - Standard pitch layout
 - Combined cricket and winter games pitches
 - Pitch markings.

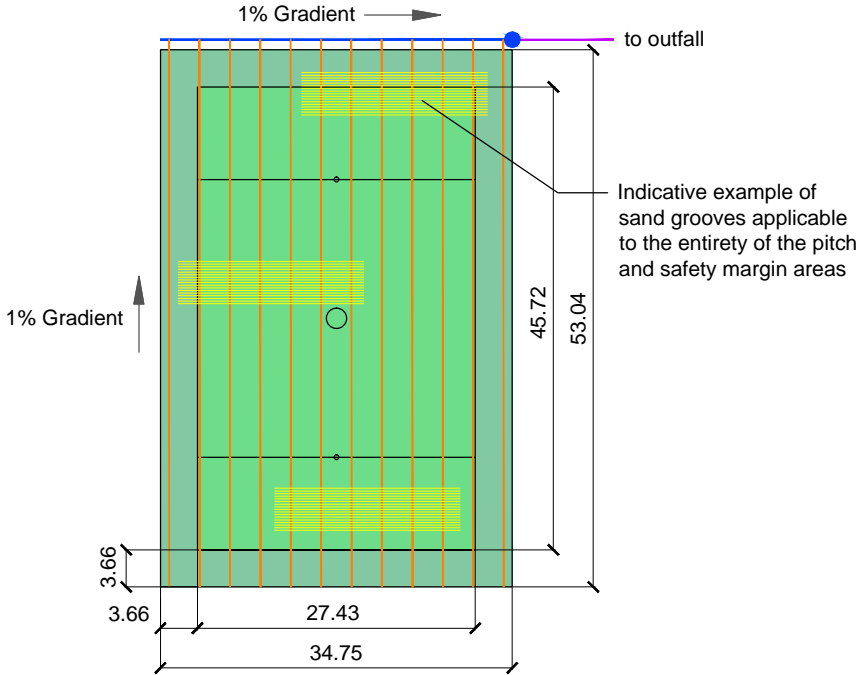

- KEY**
- 80 mm Ø corrugated perforated laterals @ 3 m intervals
 - 160 mm Ø corrugated perforated collector
 - 150 mm Ø non-perforated twin wall smooth pipe
 - Indicative sand grooves @ 0.26 m intervals
 - Inspection chamber
 - Pitch area
 - Safety margin 3.66 m wide

Playing area for Mini Soccer U8 - U7 (45.72 m x 27.43 m) - standard layout with sand grooves

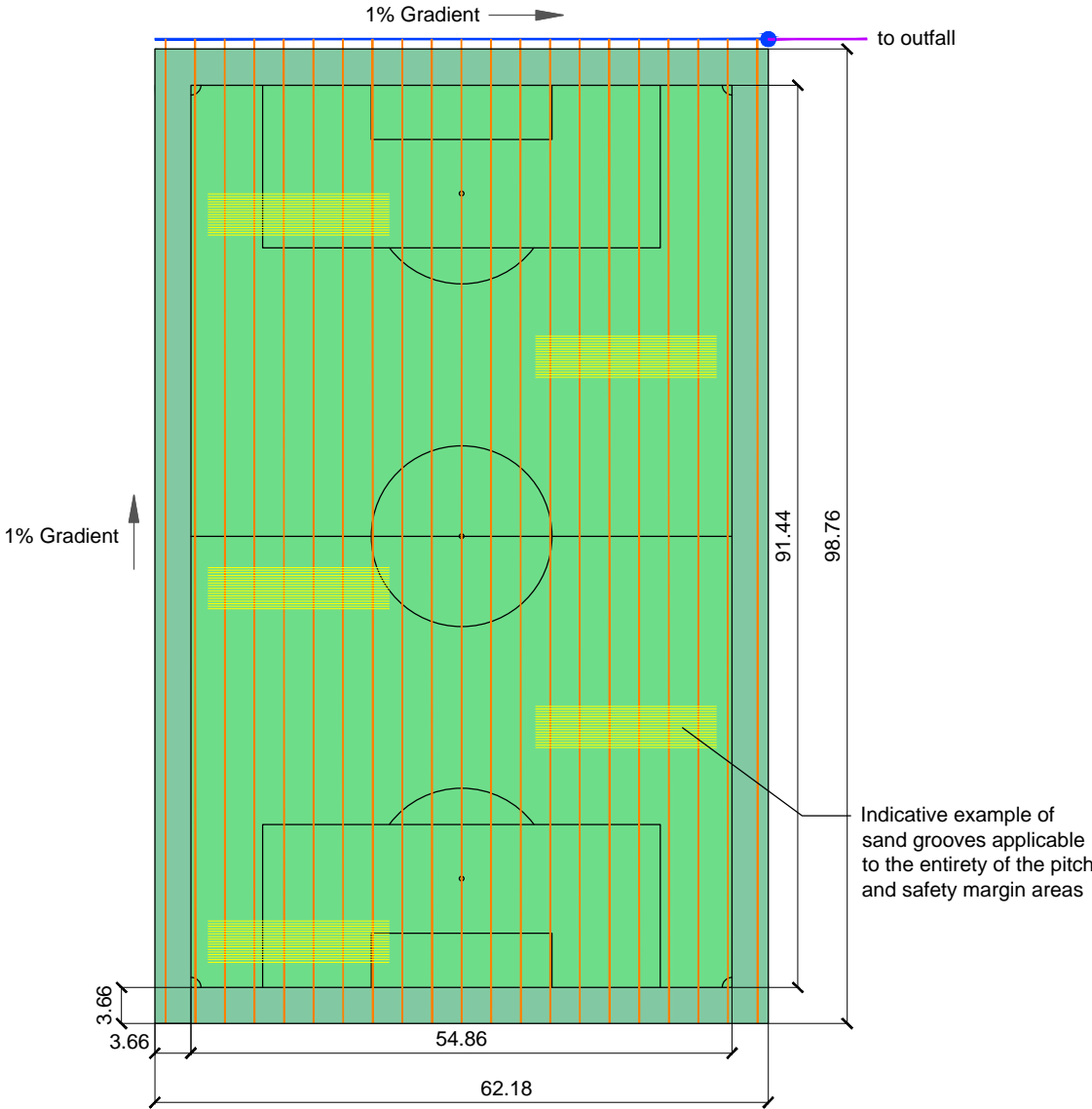

KEY

- 80 mm Ø corrugated perforated laterals @ 3 m intervals
- 160 mm Ø corrugated perforated collector
- 150 mm Ø non-perforated twin wall smooth pipe
- ▨ Indicative sand grooves @ 0.26 m intervals
- Inspection chamber
- Pitch area
- Safety margin 3.66 m wide

Playing area for Youth U15 - U16 Football (91.44 x 54.86 m) - standard layout with sand grooves

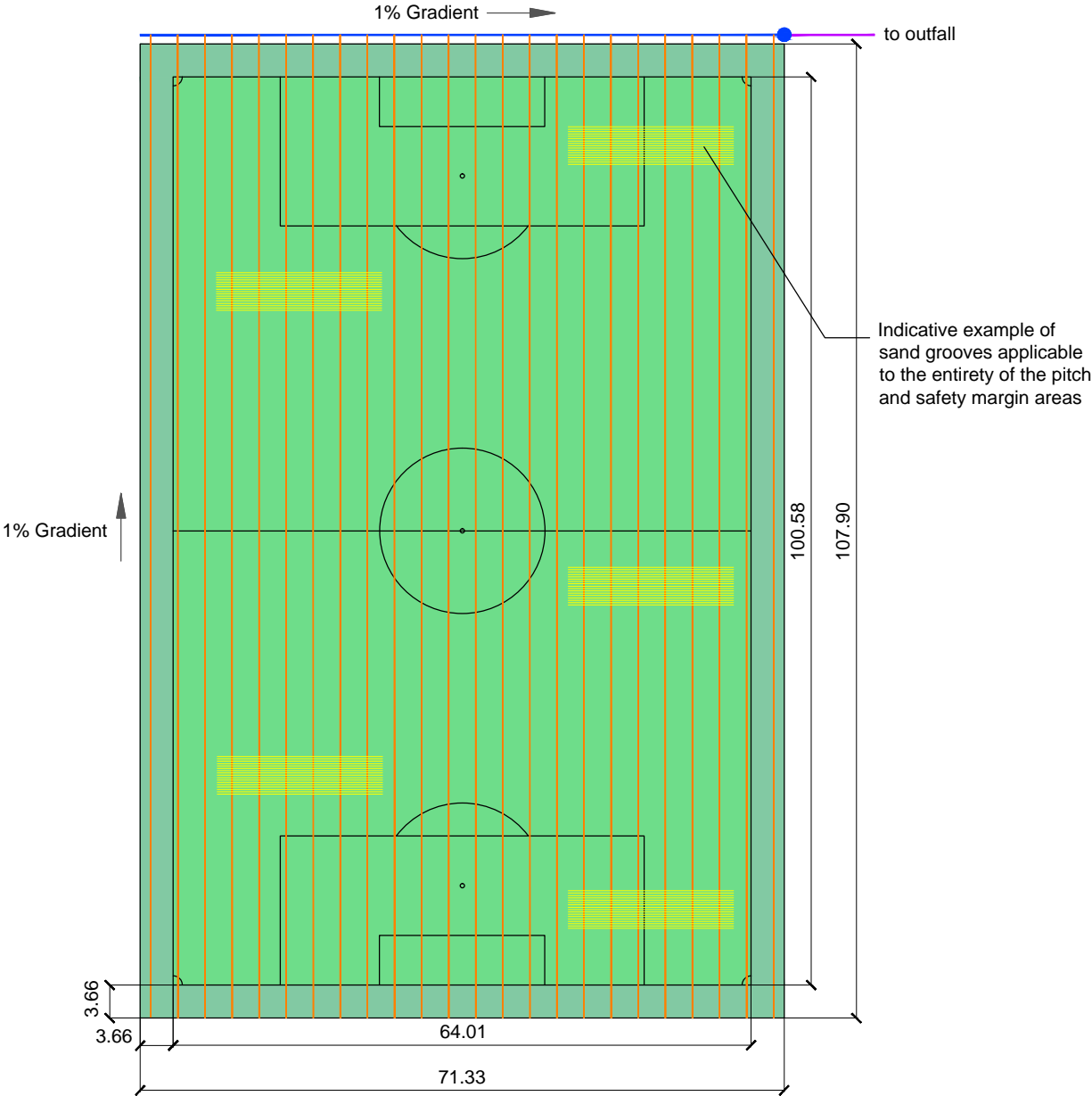

- KEY**
- 80 mm Ø corrugated perforated laterals @ 3 m intervals
 - 160 mm Ø corrugated perforated collector
 - 150 mm Ø non-perforated twin wall smooth pipe
 - ▨ Indicative sand grooves @ 0.26 m intervals
 - Inspection chamber
 - ▭ Pitch area
 - ▭ Safety margin 3.66 m wide

Playing area for Senior Football (100.58 x 54.01 m) - standard layout with sand grooves

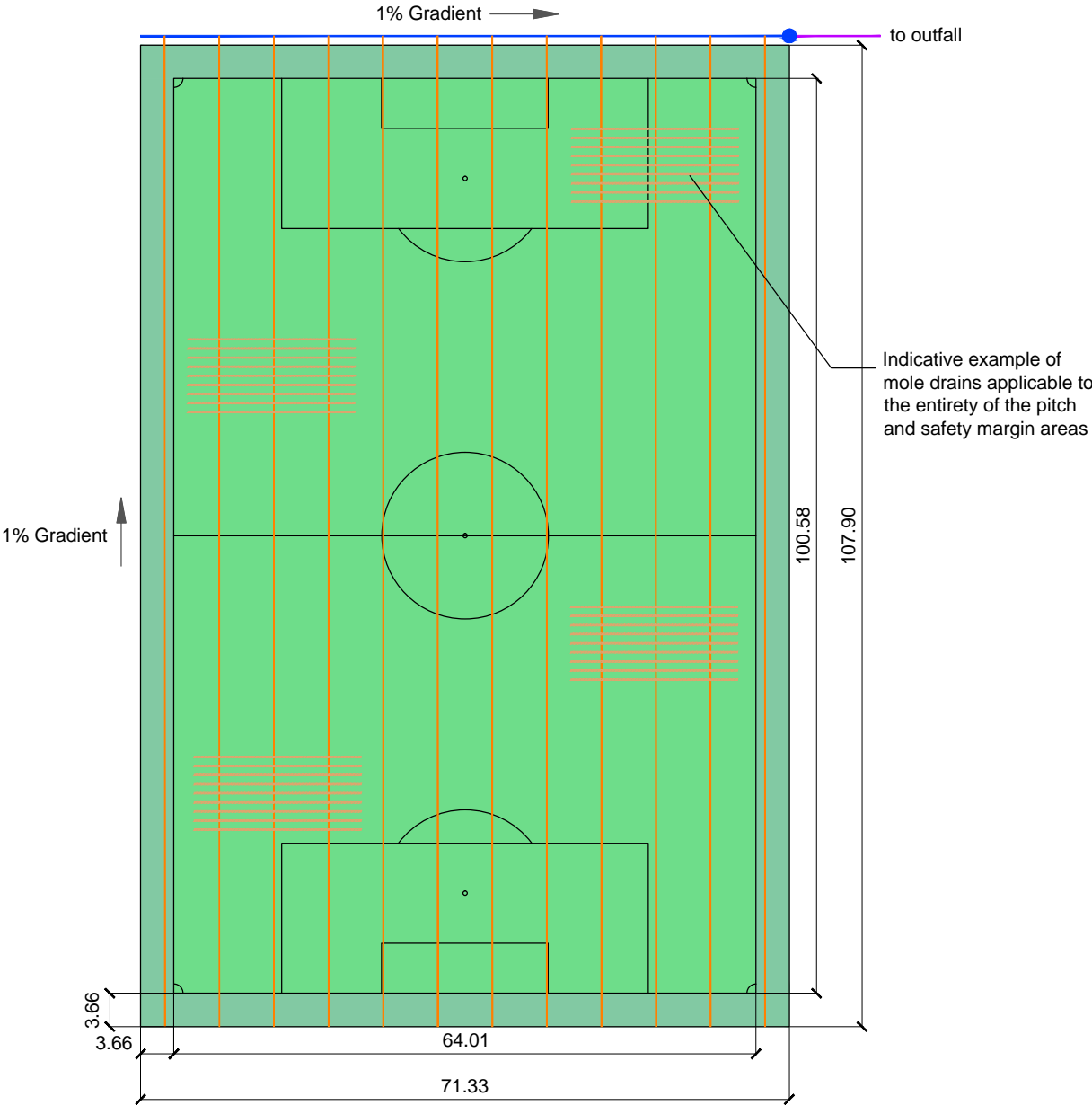

KEY

- 80 mm Ø corrugated perforated laterals @ 6 m intervals
- 160 mm Ø corrugated perforated collector
- 150 mm Ø non-perforated twin wall smooth pipe
- Indicative mole drains @ 1 m intervals
- Inspection chamber
- Pitch area
- Safety margin 3.66 m wide

Playing area for Senior football (100.58 x 64.01 m) - standard layout with mole drains

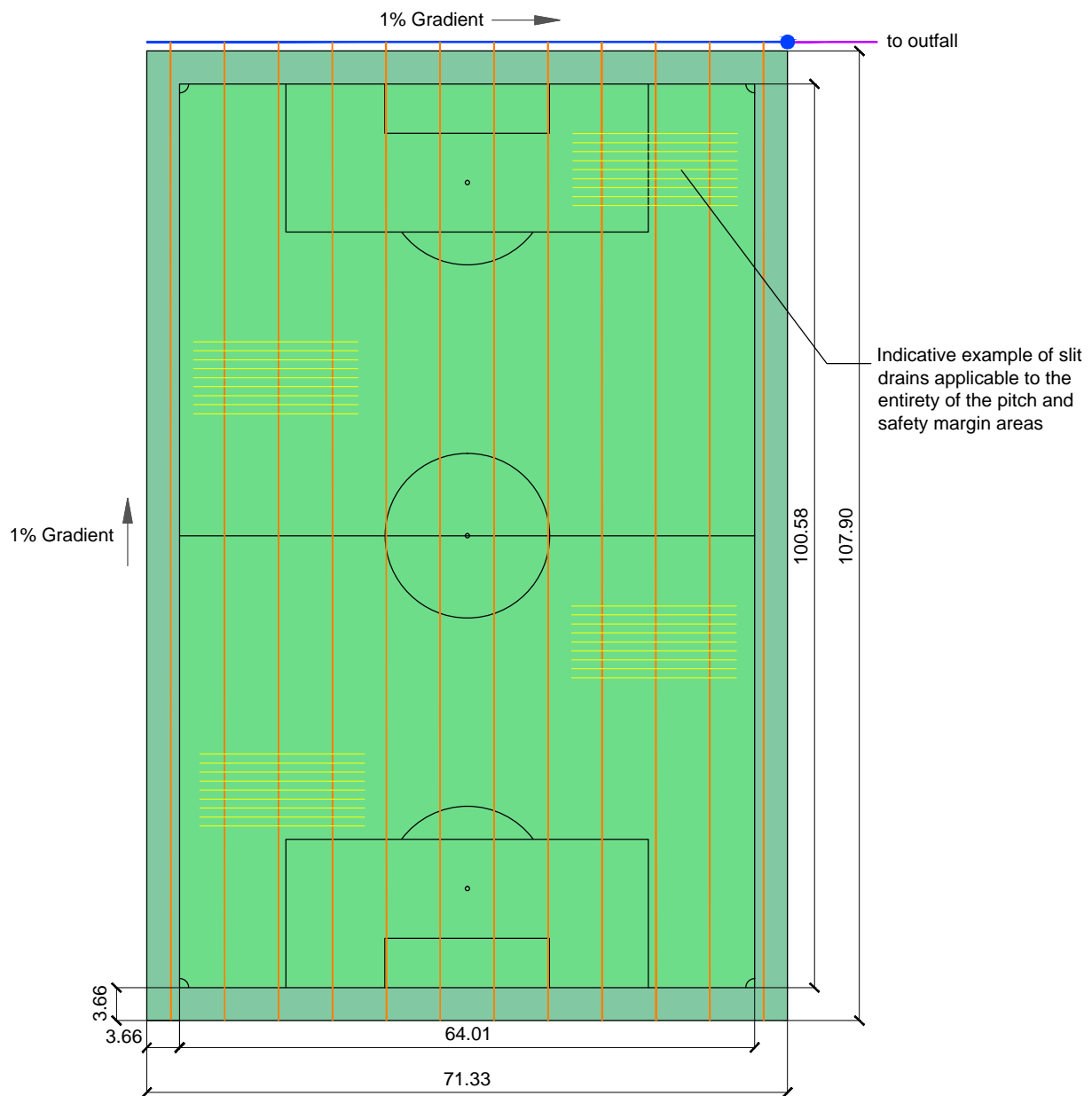

KEY

- 80 mm Ø corrugated perforated laterals @ 6 m intervals
- 160 mm Ø corrugated perforated collector
- 150 mm Ø non-perforated twin wall smooth pipe
- Indicative slit drains @ 1 m intervals
- Inspection chamber
- Pitch area
- Safety margin 3.66 m wide

Playing area for Senior / Youth U17 - U18 Football (100.58 x 64.01 m) - standard layout with slit drains

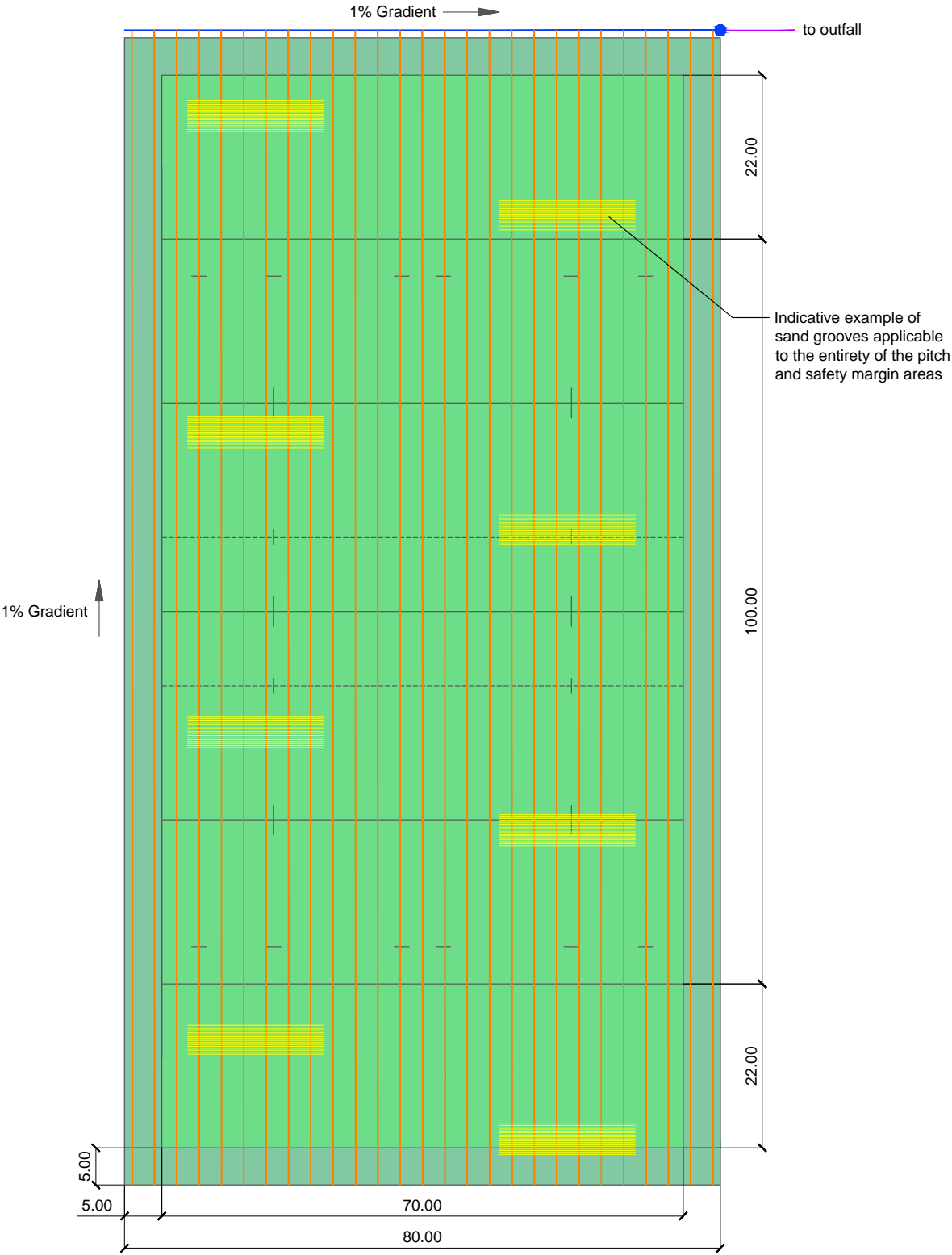

KEY

- 80 mm Ø corrugated perforated laterals @ 3 m intervals
● Inspection chamber
- 160 mm Ø corrugated perforated collector
■ Pitch area
- 150 mm Ø non-perforated twin wall smooth pipe
■ Safety margin 5.00 m wide
- Indicative sand grooves @ 0.26 m intervals

Playing area for Senior Rugby Union (100.00 m x 70.00 m) - standard layout with sand grooves

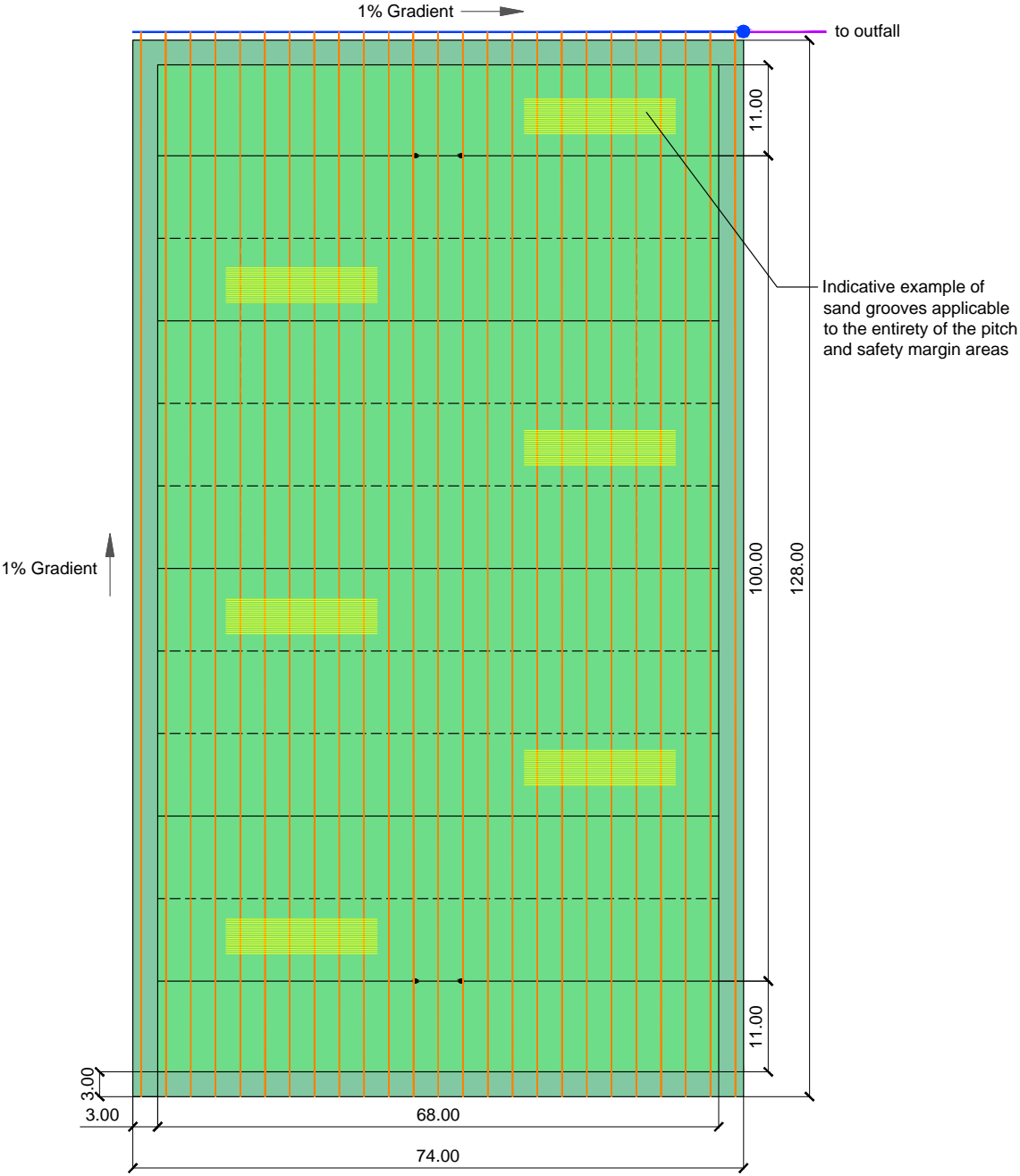

KEY

- 80 mm Ø corrugated perforated laterals @ 3 m intervals
- 160 mm Ø corrugated perforated collector
- 150 mm Ø non-perforated twin wall smooth pipe
- Indicative sand grooves @ 0.26 m intervals
- Inspection chamber
- Pitch area
- Safety margin 3.00 m wide

Playing area for Senior Rugby League (100.00 m x 68.00 m) - standard layout with sand grooves

Levels of Play	
Slowpitch dimensions (Adult)	
Mixed	Bases 19.81 m (65')
	Pitching 15.24 m (50')
	Home run 83.82 m (275')
Slowpitch dimensions (Youth)	
Over 14	Bases 19.81 m (65')
	Pitching 15.24 m (50')
Under 14	Bases 19.81 m (65')
	Pitching 14.02 m (46')
Under 12	Bases 18.29 m (60')
	Pitching 12.19 m (40')
Under 10	Bases 16.76 m (55')
	Pitching 10.67 m (35')

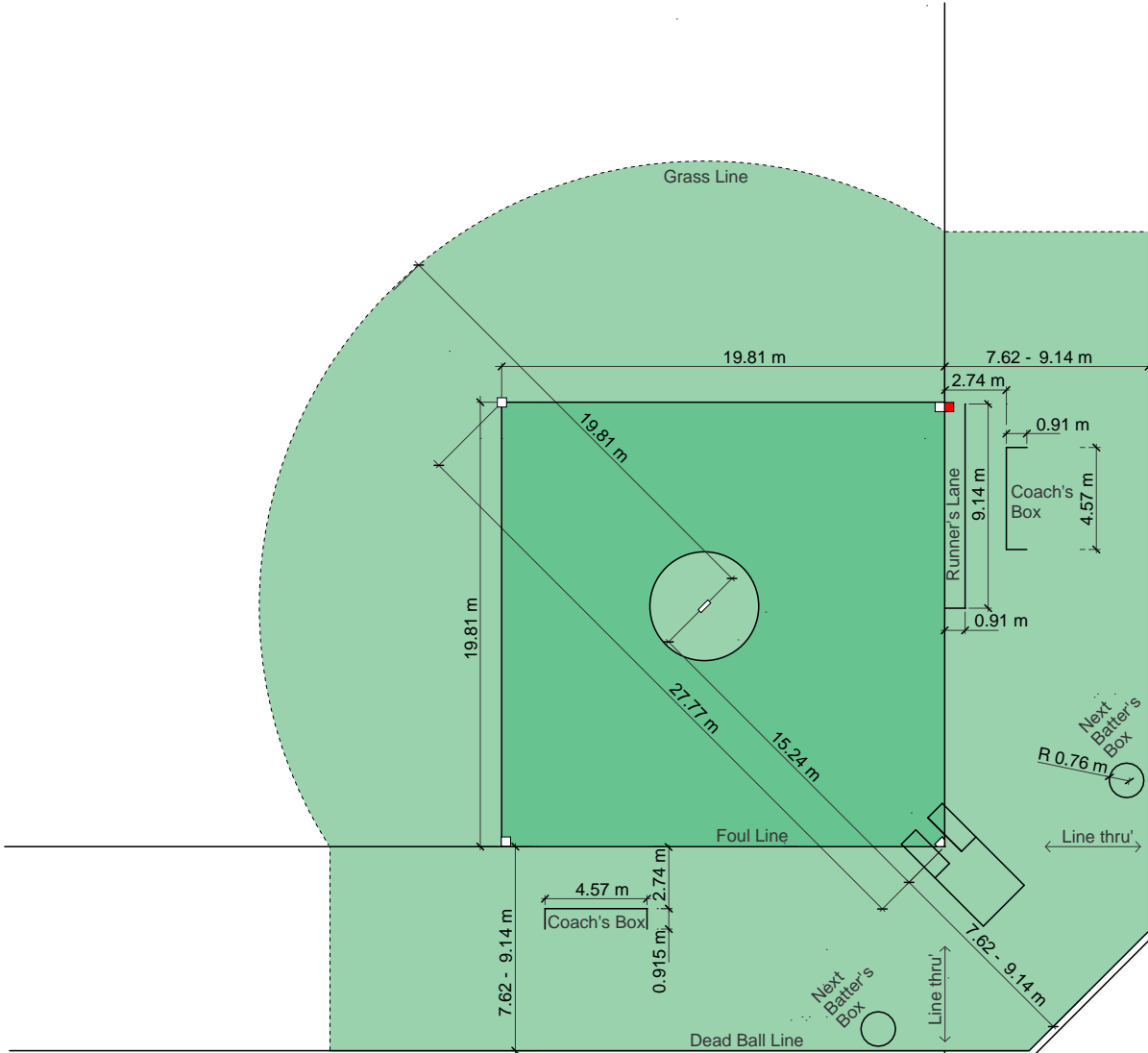
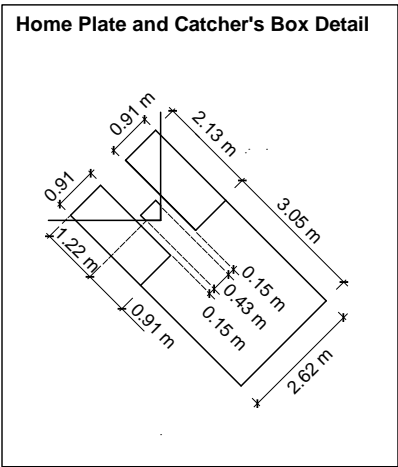
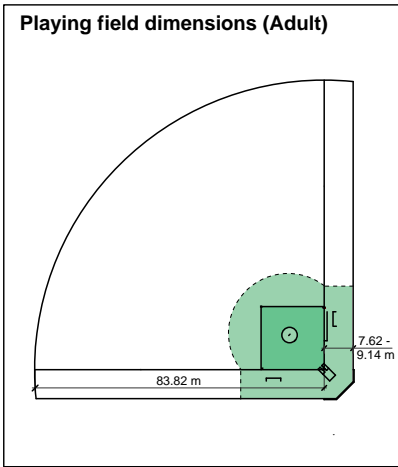

Diagram indicated is for Softball
ADULT SLOWPITCH

Note: All data based on BaseballSoftballUK / British Softball Federation guidelines

Playing area for Softball

Field Dimensions		Playing field dimensions	Home Plate and Catcher's Box Detail
Adult	Diamond Size 27.43 m (90') Pitching 18.44 m (60'6") Home Run: ◦ Left and right field min 99.05 m (325') ◦ Centre field min 121.92 m (400')		
Under 16	Diamond Size 27.43 m (90') Pitching 18.44 m (60'6") Home Run 76.20 m (250')		
Under 13	Diamond Size 21.34 m (70') Pitching 14.02 m (46') Home Run 60.96 m (200')		
Under 10 and PlayBall!	Diamond Size 18.29 m (60') Pitching 14.02 m (46') Home Run 60.96 m (200')		

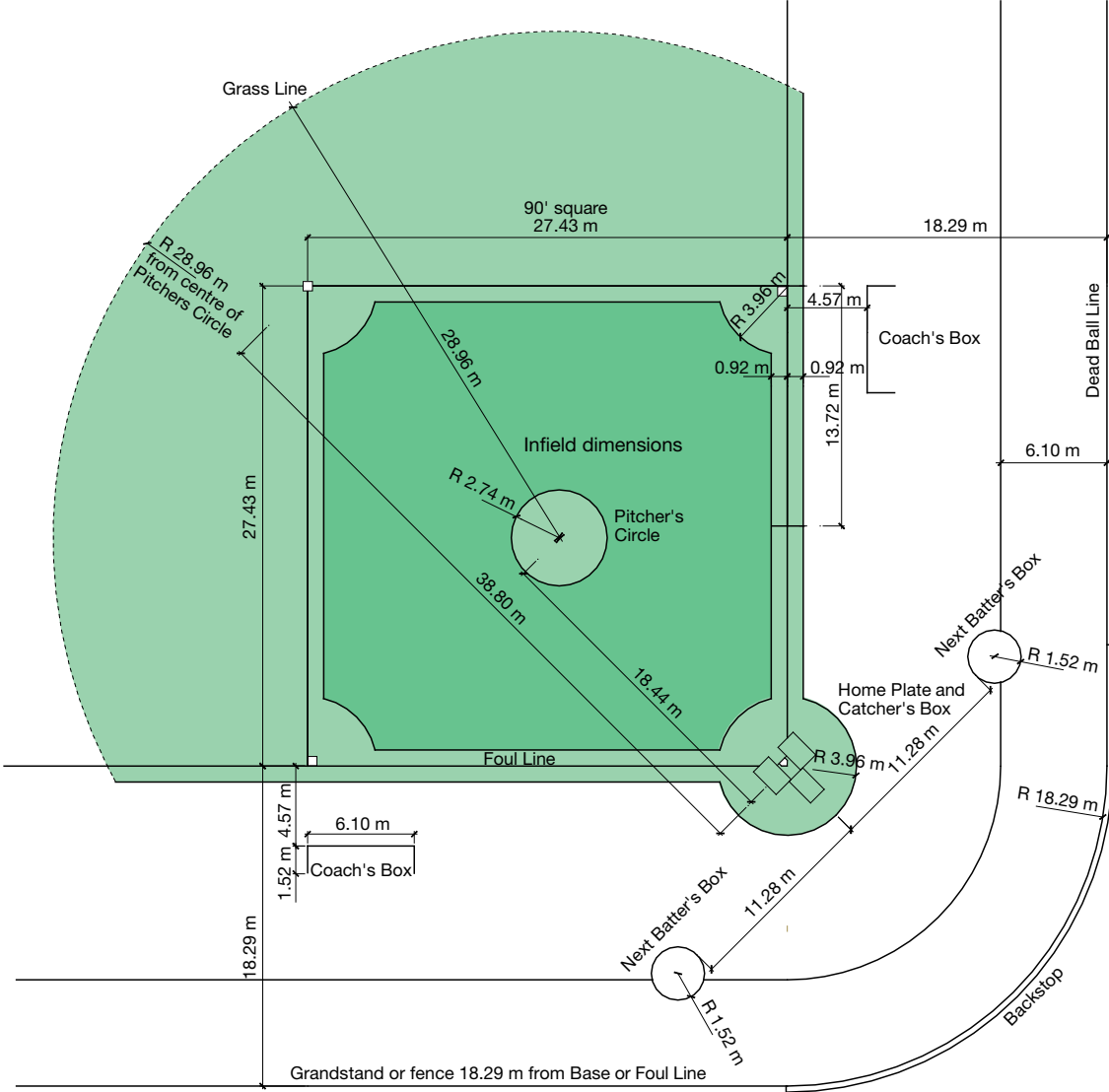
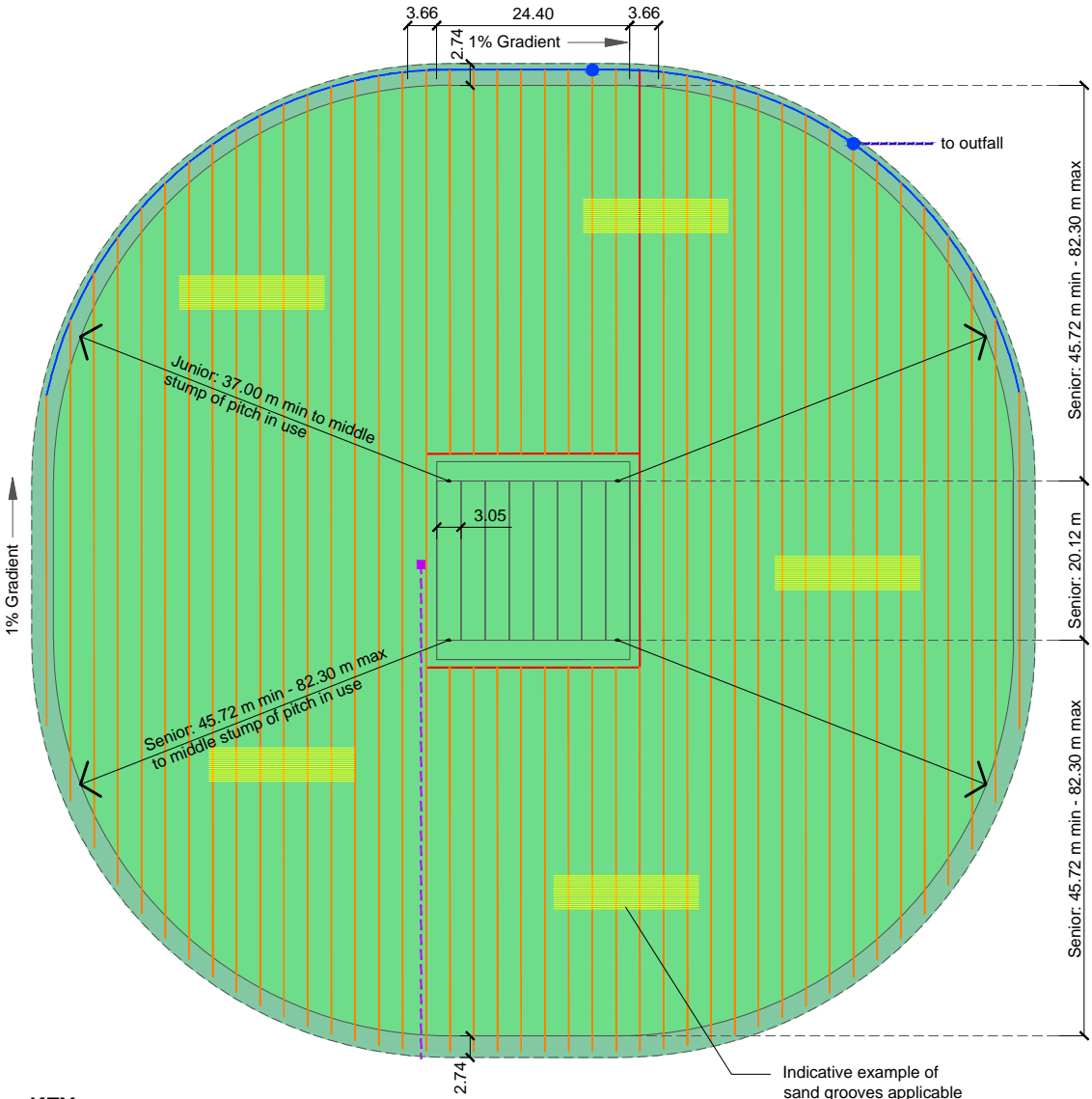

Diagram indicated is for Baseball
ADULT PITCH

Note: All data based on BaseballSoftballUK / The British Baseball Federation guidelines

Playing area for Baseball



- KEY**
- 80 mm Ø corrugated perforated laterals @ 3 m intervals
 - 100 mm Ø ring drain
 - 160 mm Ø corrugated perforated collector
 - - - 200 mm Ø non-perforated twin wall smooth pipe
 - ▨ Indicative sand grooves @ 0.26 m intervals
 - - - Irrigation pipe
 - Irrigation hydrant
 - Inspection chamber
 - Pitch area
 - Safety margin 2.74 m wide

Indicative example of sand grooves applicable to the entirety of the pitch and safety margin areas

Playing area for Senior Cricket (8 wicket pitch) - standard layout with sand grooves

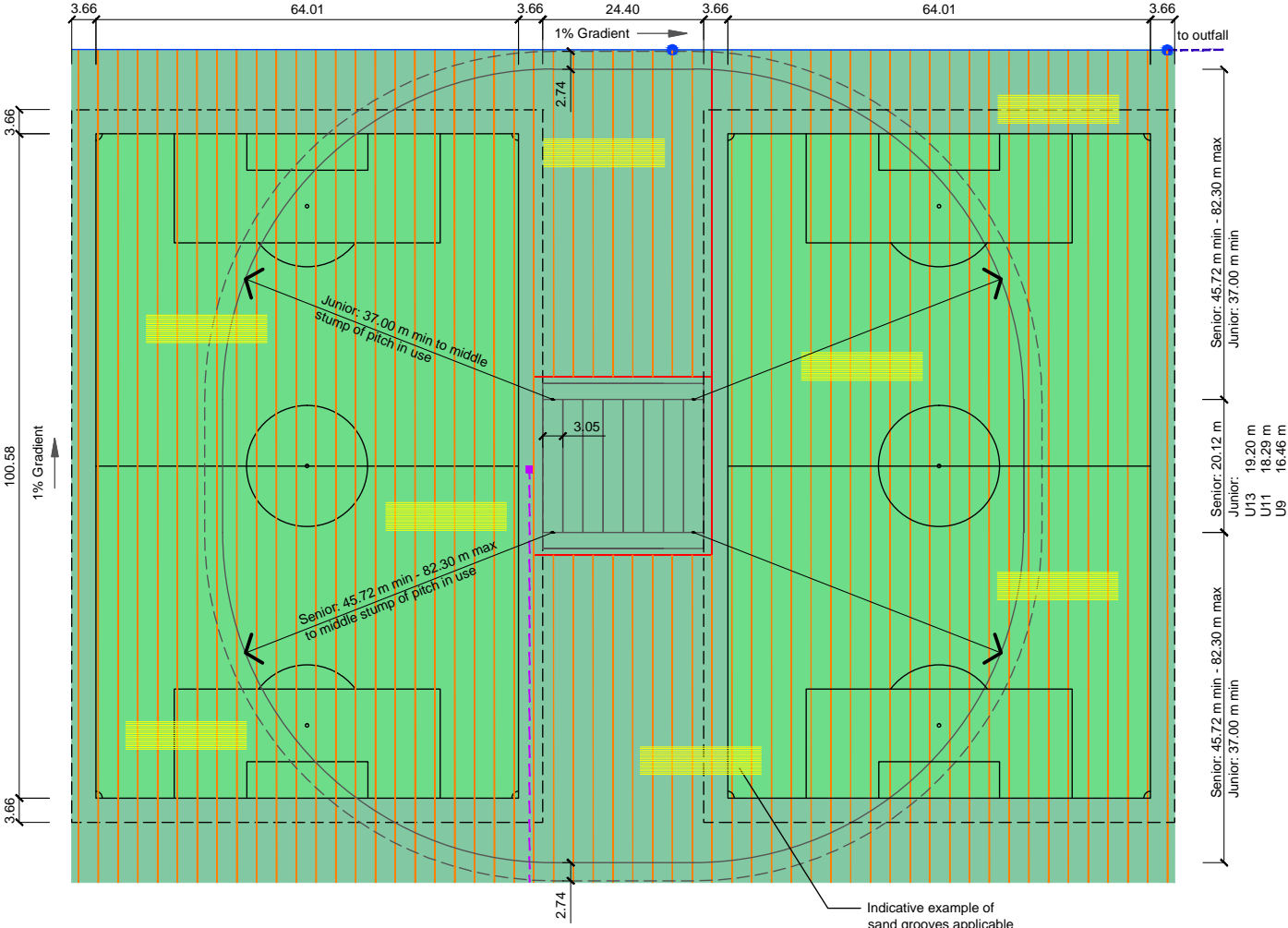

KEY

- 80 mm Ø corrugated perforated laterals @ 3 m intervals
- 100 mm Ø ring drain
- 160 mm Ø corrugated perforated collector
- - - 200 mm Ø non-perforated twin wall smooth pipe
- Indicative sand grooves @ 0.26 m intervals
- - - Irrigation pipe
- Irrigation hydrant
- Inspection chamber
- Winter sports pitch area

Indicative example of sand grooves applicable to the entirety of the pitch and safety margin areas

Playing area for Combined Cricket (8 wicket pitch) and Winter Games Pitches - standard layout with sand grooves

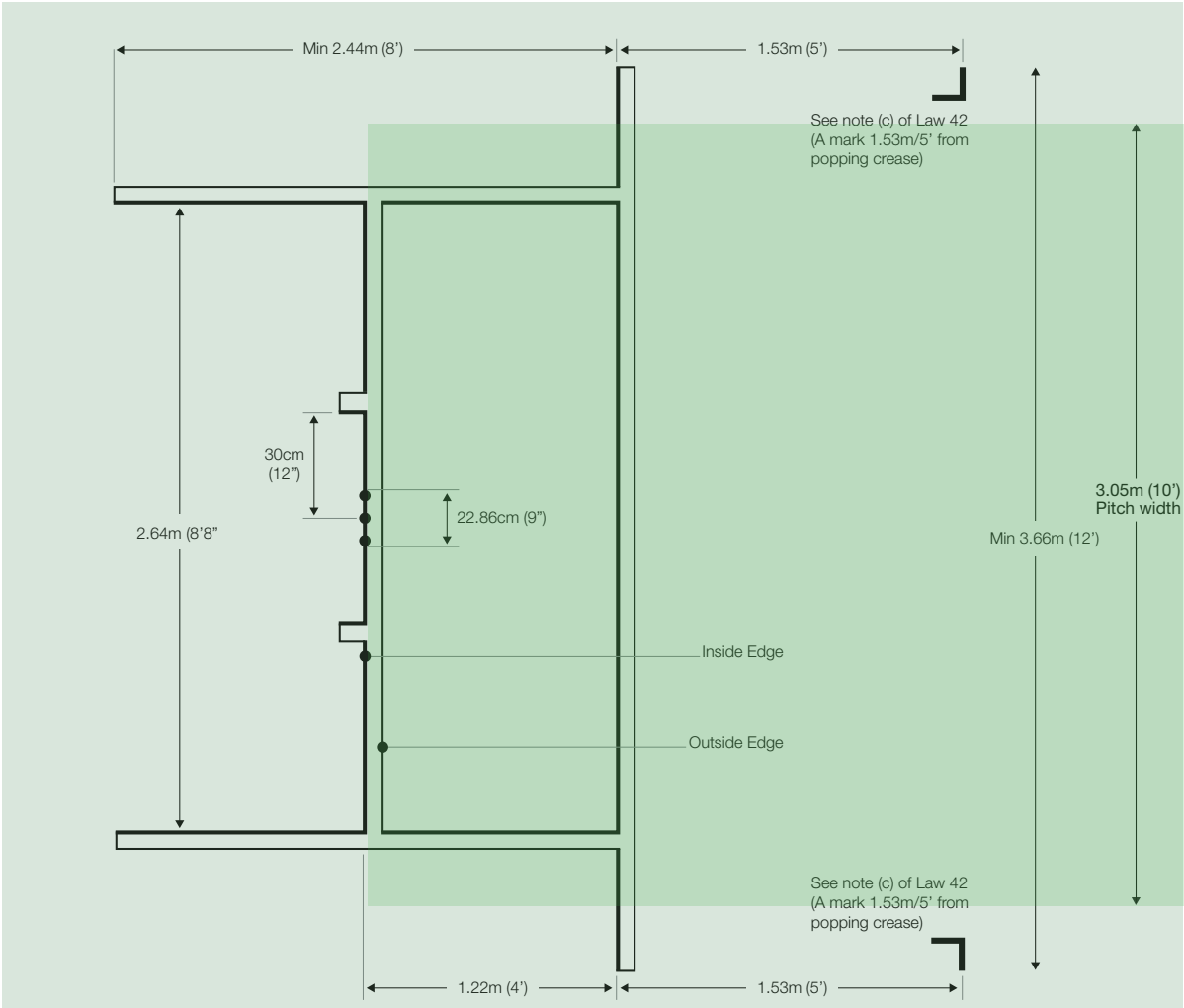

The Pitch



The Bowling, Popping and Return Creases

Based on extracts from Appendix B: Laws 7 and 9 of The MCC Laws of Cricket, Pitch Markings & ICC/ECB Playing Conditions²⁰

²⁰ Drawing taken from ECB document 'TS4 Recommended Guidelines for the construction, preparation and maintenance of cricket pitches and outfield at all levels of the game.'

APPENDIX 7

Related organisations

BaseballSoftballUK

www.baseballsoftballuk.com

BaseballSoftballUK is the development agency for baseball and softball in the United Kingdom.

Bowls England

www.bowlsengland.com

Bowls England is the National Governing Body (NGB) for the sport of flat green lawn bowls in England.

Cranfield University: Centre for Sports Surface Technology

<http://www.cranfield.ac.uk/sas/sst>

Specialist research centre involved in sport turf research including:

- the modelling of maintenance regimes that reduce CO₂ emissions and cost of turf pitches
- Guidelines for rolling in cricket
- Sports turf aeration in cricket pitches and outfields.

England and Wales Cricket Board

<http://www.ecb.co.uk/>

Governing body of Cricket in England and Wales.

Fields in Trust / National Playing Fields Association

<http://www.fieldsintrust.org/>

Fields in Trust is the new operating name for the National Playing Fields Association, a charity that owns 471 public recreation grounds set up as a memorial to King George V and campaigns to protect and promote open spaces for sports and recreation in British cities and towns.

Institute of Grounds Maintenance (IOG)

<http://www.iog.org/>

Membership organisation that promotes quality surfaces and technical expertise and represents grounds men, green keepers and all others involved in landscaping, horticulture, sports turf and amenity turf.

Land Drainage Contractors Association (LDCA)

<http://www.ldca.org/>

An association promoting best practice for contractors undertaking drainage of sports turf,

leisure and amenity areas. These include pitches at schools, colleges and universities, private sports clubs, football and rugby clubs, cricket pitches, golf courses, equestrian facilities, polo grounds and racecourses.

Lawn Tennis Association (LTA)

<http://www.lta.org.uk/>

Governing body for tennis in Britain

Learning through Landscapes

<http://www.ltl.org.uk/>

A national charity who work with schools, early years settings, organisations and individuals to improve and develop school grounds.

Playlink

<http://www.playlink.org/>

Playlink is a multi-faceted independent play and informal leisure consultancy working in the areas of design, planning, policy, strategy, local engagement, fundraising and organisational development.

Register of Independent Professional Turfgrass Agronomists (RIPTA)

<http://www.ripta.co.uk/>

The RIPTA register promotes quality standards for Independent, Professional, Turfgrass Agronomists and lists organisations that meet certain criteria. It is supplied free of charge on request to anyone with a need for such consultancy services.

Rugby Football Union

<http://www.rfu.com>

The governing body for the game of Rugby Union in England.

Sport and Play Construction Association (SAPCA)

<http://www.sapca.org.uk/>

UK trade association for the sports facility construction industry. SAPCA represents specialist constructors, manufacturers and suppliers of sports surfaces and related products and plays an important role in the promotion of high standards for sports facilities.

Sports Turf Managers Association

<http://www.stma.org>

A non-profit making professional association for the men and women who manage athletic fields worldwide.

The British Baseball Federation (BBF)

<http://www.britishbaseball.org>

The British Baseball Federation (BBF) is baseball's national governing body. It administers, develops and promotes baseball in Britain.

The British Softball Federation (BSF)

<http://www.britishsoftball.org>

The British Softball Federation (BSF) is softball's national governing body. It administers, develops and promotes softball in Britain.

Play England

<http://www.skillsactive.com/playwork>

Play England provides advice and support to promote good practice, and works to ensure that the importance of play is recognised by policy makers, planners and the public.

The Football Association

<http://www.thefa.com/>

The organisation responsible for all regulatory aspects of the game of football in England.

The Sports Turf Research Institute (STRI)

<http://www.stri.co.uk/>

A centre for turf grass research and Agronomy and an independent consultancy in sports and amenity turf including golf, football, rugby, cricket, horse racing, bowling and tennis.

Turfgrass Growers Association

<http://www.turfgrass.co.uk/>

The Association is dedicated to the advancement of quality turf productions in the UK and Ireland.

APPENDIX 8

Glossary of Natural Turf Terms

Aeration	The process of increasing the availability of air to soil and roots. Surface aeration involves the removal of thatch and debris accumulation at the base of the grass plant. Sub-surface aeration involves the creation of air-filled pathways between the surface and the soil below.
Aerator	Machinery for improving aeration including springbok rakes and scarifiers for surface aeration, and slitting, hollow tining and solid tining machines for sub-surface aeration.
Aggregate	A broad category of coarse particulate material including sand, gravel, crushed stone and recycled concrete. Due to the relatively high hydraulic conductivity value as compared to most soils, aggregates are widely used in land drainage applications.
Agronomy	The application of soil and plant sciences to land management.
Archaeology	The scientific study of past societies through artifacts, fossils, etc.
Attenuation (water)	The retention of water within the ground (and the reduction of flood water).
Blinding layer	A layer of grit which acts as a filter at the interface between coarse and fine aggregate (e.g. gravel and sand).
Bowling Crease	The bowling crease is the line through the centres of the three stumps at that end. It is 8 ft 8 in / 2.64 m in length, with the stumps in the centre.
Clay	<ul style="list-style-type: none"> • Soil, comprising very fine-grained particles (<0.002 mm), which behaves plastically when moist. • A soil textural class containing >35 % clay, <45 % sand and <45 % silt.
Chain harrow	An implement comprising a series of vertical tines, loosely linked together, that is towed across the surface to improve surface aeration and surface uniformity.
Cricket loam	A blend of sand, silt and clay tailored for use in the construction and maintenance of cricket tables.
Cultivar	A variety of a plant developed from a natural species.
Cultivation	The physical manipulation of soil using soil engaging implements.
Design and construct contract	In this type of contract, the contractor is responsible for taking a concept developed by the employer (often set out in an 'Employer's Requirements' document prepared by a consultant), completing the detailed design, and then pending the employer's approval on the design, proceed with construction.
Dragbrush	A tool for brushing in top dressing on natural turf and sand filled synthetics surfaces.
Dragmat	A tool for working in sand, top dressings and fertilizers. Can be used as a hand tool or drawn behind a small tractor.
Drainage	The removal of excess water held within the soil or ponding on the surface.
Drainage layer	An alternative term for a 'raft' which is a layer of gravel or stone chippings typically constructed 300 mm beneath a sports field to provide a means of collecting excess drainage water.
Drift	Transported rock debris overlying solid bedrock.
Ecology	The branch of biology concerned with the relationship between organisms and their environment.
Environmental Management Plan	A document providing a framework for dealing with the pollution risks associated with a site and activities on that site.
Fertilizer	Nutrients that are applied to soil to make it more fertile.
Friable	A term to describe the condition of soil when it is prone to crumbling rather than to deforming plastically.

Geology	A science that deals with the history of the earth as recorded in rocks.
Geotextile	Permeable fabric used to separate, filter, reinforce or protect soil.
Grading	The process of using cultivation to improve uniformity of surface levels.
Gradient	The slope across a playing field.
Grass	Species of vegetation used as a ground cover for aesthetic purposes or recreational use.
Gravel	Any loose rock that is larger than 2 mm in its smallest dimension and no more than 64 mm in its largest dimension.
Grit bands	Narrow grit-filled trenches, typically 30 mm wide and 250 mm deep, installed above a network of lateral drains to improve surface drainage.
Gulley	A surface drain comprising an perforated cover, set just below the surrounding land to provide a receptor for water accumulating on the surface.
Heeling	The consolidating of soil into an excavated area by a person using the heel of the foot.
Herbicide	A chemical agent that destroys plants or inhibits their growth.
Hollow tine aeration	The process of removing cores of soil, using hollow tines, to improve aeration and address soil compaction.
Hydrology	A branch of geology that studies water on the earth and in the atmosphere.
Infiltration	The movement of water through the surface of a playing field.
Irrigation	The application of water to land.
Isopachytes	A line on a map connecting points below which a particular rock stratum has the same thickness.
Loam	Soil comprising a blend of sand, silt and clay.
Lute	A tool for grading loose soils prior to seeding or turfing or for incorporating and levelling topdressings.
Marl	A loose and crumbling earthy deposit consisting mainly of calcite or dolomite.
Mottles	Spots of different colours (typically red) on the surface of a broken lump of soil which is indicative of seasonal water logging.
Outfall	A point at which water exits a drainage system (typically into a ditch or watercourse). A 'positive outfall' is where the difference in levels ensures that the drainage water is always flowing.
Over seeding	Application of additional seed to an existing sports field to address grass loss through wear.
Percolation rate	The rate at which water moves through soil.
Permeability	The readiness with which soil can be pervaded by water.
Performance Quality Standard (PQS)	The minimum acceptable performance criteria for a playing surface (e.g. drainage capacity, hardness etc.) for different levels of the game (e.g. local, regional or national).
Pesticides	A chemical used to kill pests.
Popping crease	The popping crease is in front of, and parallel to, the bowling crease and 4 ft / 1.22 m from it. The popping crease is marked to a minimum of 6 ft / 1.83 m on either side of the imaginary line joining the centres of the two middle stumps and is considered to be unlimited in length.
Pop-up irrigation	An irrigation system comprising an arrangement of sprinklers that rise above the playing surface during operation and return to a position that is flush with, or just below, the surface upon completion.
Positive outfall	An efficient means of disposal of excess drainage water emanating from a drainage scheme (typically a ditch or watercourse).

Raft	An alternative term for a 'drainage layer' which is a layer of gravel or stone chippings typically constructed 300 mm beneath a sports field to provide a means of collecting excess drainage water.
Reinforcement	The inclusion of synthetic fibres within the rootzone to increase wear resistance and strength.
Return Crease	The return creases are at right angles to the popping crease at a distance of 4 ft 4 in / 1.32 m either side of the imaginary line joining the centres of the two middle stumps. Each return crease is marked from the popping crease to a minimum of 8 ft / 2.44 m behind it and shall be considered to be unlimited in length.
Rootzone.	<ul style="list-style-type: none"> • The region within the soil profile where the majority of roots are located. • A blend of sand and soil used to construct sports surfaces.
Run-off	The movement of excess water across the surface of a playing field following significant rainfall.
Safety margin	An additional area around the perimeter of a court or pitch to reduce the risk of injury to players as a result of interaction with adjacent games or site infrastructure.
Sand amelioration	The application and incorporation of sand into the surface of a sports field to improve playability.
Sand grooves	Narrow slits, approximately 150 mm deep and 20 mm wide, introduced by a machine at a spacing of 260 mm to improve surface drainage. These grooves are forced into the soil with a tine rather than being created by excavating a narrow trench, and can be filled with sand or fine grit.
SAPCA	A UK trade association for the sports facility construction industry (Sport and Play Construction Association). SAPCA represents specialist constructors, manufacturers and suppliers of sports surfaces and related products, and plays an important role in the promotion of high standards for sports facilities.
Scarification	A process of mechanical raking the turf surface in order to remove underlying thatch or moss material.
Secondary drainage	Drainage systems designed to intercept surface water and convey it to a subsurface drainage system (e.g. sand grooves, slit drains and grit bands).
Seedbed	A term referring to the state of soil following preparation for seeding (i.e. through cultivation). Typically, the tilth would be characterised by fine crumb structure.
Silt	Soil comprising fine-grained particles (0.060 mm to 0.002 mm).
Site Waste Management Plan	A document that sets out how resources will be managed and waste controlled at all stages during a construction project. In England, a site waste management plan (SWMP) is required for all construction projects worth more than £300,000.
Slit drains	a series of narrow, commonly 50 mm wide, sand and gravel filled trenches excavated across, and into the porous backfill of, lateral drains below. Slit drains are typically 250 to 350 mm deep and installed at 0.5 to 2.0 m spacing.
Specification	An explicit set of requirements to be satisfied by a material, product, or service.
Springbok rake	A hand tool for thatch and moss removal and leaf raking.
Soakaway	An underground structure that disposes of unwanted water, most commonly storm water runoff, by dissipating it into the ground, where it merges with the local groundwater.
Soil compaction	A reduction of air-filled pore space in soil following loading, resulting in an increase in dry bulk density.
Soil profile	A cross-section through an area of land.
Soil Texture	A description of the proportion of grain and mineral particle sizes in soil.
Subsoil	The layer of soil under the topsoil.
Subsoiler	A tractor-drawn implement for alleviating compaction in the subsoil.

Suspended water table	Sports field or golf green construction that provides maximum removal of water during heavy rain, but stores water in rootzone above a gravel raft during periods when the ground is not saturated.
Sustainable Urban Drainage Systems (SUDS)	Water management practices and facilities designed to drain surface water in a manner that will provide a more sustainable approach than what has been the conventional practice of routing run-off through a pipe to a watercourse.
Sward	Expanse of short grass.
Switch	Hand tool designed to remove dew, debris and worm casts from the surface of fine turf.
Tilth	A term referring to the state of soil following tillage (cultivation with soil-engaging implements).
Tine	A soil-engaging implement.
Thatch	The accumulation of partially decomposed organic matter at the base of a grass sward.
Top dressing	<ul style="list-style-type: none"> • The application of sand or rootzone to the surface. • The application of fertilizer to a growing crop (mainly in agriculture).
Topography	The practice of graphic delineation in detail, usually on maps or charts, of natural and man-made features
Topsoil	The soil horizon immediately below the grass sward (typically extending to between 100 and 300 mm below the surface).
Traditional contract	In such a contract the employer contracts with an architect, engineer or consultant to carry out the design. The architect, engineer or consultant, acting as the agent of the employer, supervises the construction of that design. The contractor enters into a contract with the employer to build that design.
Turf	A grass, root and soil system maintained for aesthetic purposes or recreational use
Turfbed	A term referring to the state of soil following preparation for turfing (i.e. through cultivation). Typically, the tilth would be characterised by fine crumb structure.
Twin wall pipe	Drainage pipe that is corrugated on the outside to provide additional strength, but smooth on the inside to reduce frictional losses during the conveyance of water.
Verti-drainer	A tined aerator typically used to alleviate soil compaction by imparting 'heave' during the operation to create cracks and fissures in the soil.
Waste Acceptance Criteria (WAC)	<p>Criteria to be met before waste is accepted at a landfill site. There are different acceptance criteria for:</p> <ul style="list-style-type: none"> • Inert waste • Non-hazardous waste • Hazardous waste.
Watercourse	Any flowing body of water including rivers, streams and brooks.
Wacker plate	A machine, comprising a vibrating plate, for compacting soil (also known as a soil plate compactor).



Alternative Languages and Formats:

This document can be provided in alternative languages, or alternative formats such as large print, Braille, tape and on disk upon request.

Call the Sport England switchboard on 08458 508 508 for more details.

Information Prepared By:

Sport England, Robin Wilson Consulting & S&P Architects

Acknowledgements:

Sport England is indebted to the individuals and organisations that have contributed to this guidance note with excellent advice, information and photographic material. In particular (in alphabetical order):

Alan Fergusson, Head Groundsman, Ipswich Town Football Club

Dr Iain James, Centre for Sports Surface Technology, Cranfield University

Dr Richard Earl, TGMS Ltd, Cranfield Innovation Centre

Institute of Groundsmanship (IOG)

Labosport UK

Maber Architects

Materials Science Consultants (MSC)

Sport and Play Construction Association (SAPCA)

Sports Turf Research Institute (STRI)

Stock Exchange

User Guide:

Before using this design guidance note for any specific projects all users should refer to the User Guide to understand when and how to use the guidance as well as understanding the limitations of use.

[Click here for 'User Guide'](#)

[Click here for current 'Design and Cost Guidance'](#)

Issue Tracker

002 – Reformatted with amendments: May 2011

001 – Initial Publications: March 2000

Sport England

3rd Floor Victoria House
Bloomsbury Square
London
WC1B 4SE

Tel : +44 (0)8458 508 508

Fax: +44 (0)20 7383 5740

Email: info@sportengland.org

Web: <http://www.sportengland.org>

 Awarding funds from
The National Lottery[®]

© Sport England, May 2011